

UNCLASSIFIED

AD NUMBER

AD503840

LIMITATION CHANGES

TO:

Approved for public release; distribution is unlimited. Document partially illegible.

FROM:

Distribution authorized to U.S. Gov't. agencies and their contractors;
Administrative/Operational Use; MAY 1969. Other requests shall be referred to Army Assistant Chief of Staff for Force Development, Washington, DC 20310. Document partially illegible.

AUTHORITY

ago, d/a ltr dtd 29 apr 1980

THIS PAGE IS UNCLASSIFIED

UNCLASSIFIED

AD NUMBER

AD503840

CLASSIFICATION CHANGES

TO:

UNCLASSIFIED

FROM:

CONFIDENTIAL

AUTHORITY

ago, d/a ltr 29 apr 1980

THIS PAGE IS UNCLASSIFIED

SECURITY

MARKING

The classified or limited status of this report applies to each page, unless otherwise marked.

Separate page printouts MUST be marked accordingly.

THIS DOCUMENT CONTAINS INFORMATION AFFECTING THE NATIONAL DEFENSE OF THE UNITED STATES WITHIN THE MEANING OF THE ESPIONAGE LAWS, TITLE 18, U.S.C., SECTIONS 793 AND 794. THE TRANSMISSION OR THE REVELATION OF ITS CONTENTS IN ANY MANNER TO AN UNAUTHORIZED PERSON IS PROHIBITED BY LAW.

NOTICE: When government or other drawings, specifications or other data are used for any purpose other than in connection with a definitely related government procurement operation, the U.S. Government thereby incurs no responsibility, nor any obligation whatsoever; and the fact that the Government may have formulated, furnished, or in any way supplied the said drawings, specifications, or other data is not to be regarded by implication or otherwise as in any manner licensing the holder or any other person or corporation, or conveying any rights or permission to manufacture, use or sell any patented invention that may in any way be related thereto.

CONFIDENTIAL



DEPARTMENT OF THE ARMY
OFFICE OF THE ADJUTANT GENERAL
WASHINGTON, D.C. 20310

IN REPLY REFER TO

AGAM-P (M) (28 Jul 69) FOR OT UT 692068

4 August 1969

SUBJECT: Operational Report - Lessons Learned, Headquarters, I Field Force Vietnam, Period Ending 30 April 1969 (U)

SEE DISTRIBUTION

1. Subject report is forwarded for review and evaluation in accordance with paragraph 5b, AR 525-15. Evaluations and corrective actions should be reported to ACSFOR OT UT, Operational Reports Branch, within 90 days of receipt of covering letter.
2. Information contained in this report is provided to insure appropriate benefits in the future from lessons learned during current operations and may be adapted for use in developing training material.

BY ORDER OF THE SECRETARY OF THE ARMY:

KENNETH G. WICKHAM
Major General, USA
The Adjutant General

1 Incl
as

DISTRIBUTION:

Commanding Generals

US Continental Army Command
US Army Combat Developments Command

Commandants

US Army War College
US Army Command and General Staff College
US Army Air Defense School
US Army Armor School
US Army Aviation School
US Army Chaplain School
US Army Chemical School
US Army Civil Affairs School
US Army Combat Surveillance School
US Army Engineer School
US Army Field Artillery School
US Army Infantry School
US Army Intelligence School

Regraded unclassified when separated
from classified inclosure.

CONFIDENTIAL

DISCLAIMER NOTICE

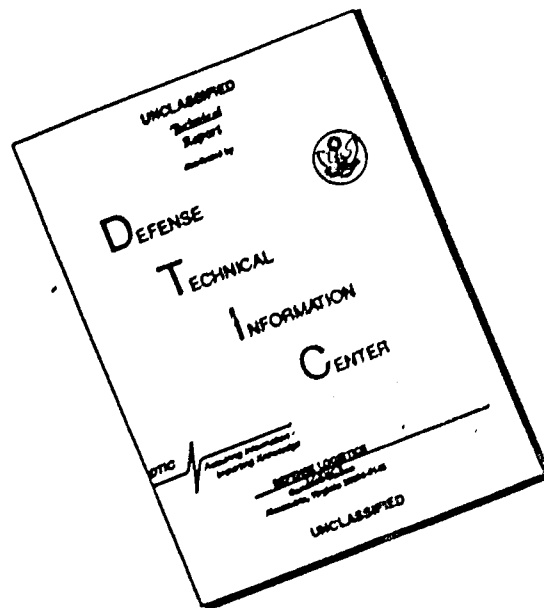

THIS DOCUMENT IS BEST QUALITY AVAILABLE. THE COPY FURNISHED TO DTIC CONTAINED A SIGNIFICANT NUMBER OF PAGES WHICH DO NOT REPRODUCE LEGIBLY.

CONFIDENTIAL

DISTRIBUTION (Cont'd)

- US Army Medical Field Service School
- US Army Military Police School
- US Army Missile and Munitions School
- US Army Ordnance School
- US Army Quartermaster School
- US Army Security Agency School
- US Army Signal School
- US Army Southeastern Signal School
- US Army Special Warfare School
- US Army Transportation School
- US Army CBR Weapons Orientation Course

Copies furnished:

- Office, Chief of Staff, US Army
- Deputy Chiefs of Staff
- Chief of Research and Development
- Assistant Chiefs of Staff
- Chief of Engineers
- The Surgeon General
- The Provost Marshal General
- Judge Advocate General
- Commander In Chief, US Strike Command
- Commanding Generals
 - US Army STRATCOM
 - I Field Force Vietnam
- Commander, US Army Forces Southern Command
- Chief of Staff, USAF
- Commandant of the Marine Corps
- Senior Army Representative, Marine Corps Development & Education Command
- Joint Action Control Office
- Defense Documentation Center
- Security Officer, Hudson Institute
- Commanding Officers
 - US Army Limited War Laboratory
 - US Army Logistics, Doctrine Systems & Readiness Agency
 - US Army Mobility Equipment Research & Development Center

CONFIDENTIAL

CONFIDENTIAL

DEPARTMENT OF THE ARMY
Headquarters I Field Force Vietnam
APO San Francisco 96350

AVFA-GC-OT

15 May 1969

SUBJECT: Operational Report of Headquarters, I FFORCEV for Quarterly
Period Ending 30 April 1969 RCS CSPCR-65 (R1) (U)

SEE DISTRIBUTION

1. Section I - SIGNIFICANT ORGANIZATION OR UNIT ACTIVITIES

a. (C) General:

(1) During February, March and April 1969, United States and Free World Military Forces (FWMF) with 57 maneuver battalions (19 US and 18 ROK) supported by 24 artillery battalions (16 US and 8 ROK) and the Army of the Republic of Vietnam (ARVN) with 30 maneuver battalions supported by seven artillery battalions continued to conduct operations in the II Corps Tactical Zone (II CTZ). Operations were conducted in the west along the Cambodian/Laotian/Republic of Vietnam border in Quang Duc, Darlac, Pleiku and Kontum Provinces; along the east coast in Binh Dinh, Phu Bon, Phu Yen, Khanh Hoa and Ninh Thuan Provinces; and in the south in Tuyen Duc, Long Dong and Binh Thuan Provinces. The quarter started with enemy activity at a low level consisting primarily of stand off attacks against allied installations and civilian population centers. On 21-22 Feb, the long awaited Communist Winter/Spring Offensive commenced with the prime target being the pacification program and its related activities. By mid-March, this offensive had collapsed. In the central highlands, two North Vietnamese Army (NVA) regiments were detected as they attempted to infiltrate and were forced to withdraw into Cambodia and Laos. Highly significant during this offensive was the enemy's use of some armor and large calibre artillery. By the end of the reporting period, enemy activities had returned to the low level experienced at the beginning of the quarter. Allied forces returned to support of the Accelerated Pacification Campaign (APC), providing security for population centers and working closely with Government of Vietnam (GVN) officials. A major readjustment of forces was made in northern II CTZ in support of the pacification program. Small unit operations saturated wide areas in order to detect and destroy the enemy forces as they attempted to move. Border surveillance was maintained to detect any movement of NVA forces back into II CTZ.

(2) Friendly losses for the period were 1139 KIA, 3959 WIA and 87 MIA. Enemy losses were 5708 KIA, 454 PWs and 1874 small arms (SA) and 182 crew served weapons (CSW) captured. II CTZ accounted for 582 Hoi Chanh (238 military).

b. (C) Intelligence:

(1) General. Intelligence operations during the period showed a high degree of flexibility, fully supporting both the pacification campaign and friendly action directed at thwarting the enemy's Winter/Spring Offensive. In a continuation of the trend reported last period, heavy emphasis was placed on the enemy's political activity and the

FOR OT UT
692068
Inclosure

DOWNGRADED AT 3 YEAR INTERVALS;
DECLASSIFIED AFTER 12 YEARS.
DOD DIR 5200.10

CONFIDENTIAL

CONFIDENTIAL

AFSA-GC-02

15 May 1969

SUBJECT: Operational Report of Headquarters, I FFORCEV for quarterly
Period Ending 30 April 1969 RCS CSPOR-65 (R1) (U)

pacification aspects of the war. The I FFORCEV intelligence agencies have amassed a comprehensive data base on the Communist's political and low level activities. This has allowed identification of critical areas requiring intensive Allied efforts to destroy the VC infrastructure and its influence over the population. In addition, the combined intelligence effort has indicated tactics and techniques useful in combating the enemy's political attack. Continued monitoring of both the enemy's political goals and his conventional military activity provided early warning of the Winter/Spring Offensive and made possible friendly preemptive action which significantly blunted the intensity of his attacks.

(2) Enemy Order of Battle.

(a) Disposition of NVA, VC Main Forces and VC Local Forces is shown at Inclosure 1.

(b) Changes in Order of Battle holdings during the period:

<u>1. Units Accepted:</u>	<u>UNIT</u>	<u>CLASSIFICATION</u>	<u>STRENGTH</u>
	200C Infil Bn	Probable	250
	K-25A Engr Bn	Confirmed	250
	K-25B Engr Bn	Confirmed	250
	481st LF Bn	Probable	150
	482B LF Bn	Confirmed	130
	K-29 LF Bn	Probable	250
	K-20 Sapper Bn	Probable	240
	K-41 Arty Bn	Probable	Unk
	K-42 Arty Bn	Possible	Unk
<u>2. Units Removed:</u>	95th NVA Regt (except 13th Bn)	Confirmed	1115 (to III Corps)
	18B NVA Regt (except 7th Bn)	Possible	1000 (to III Corps)
	101D NVA Regt	Confirmed	1175 (to III Corps)

3. Changes in Subordination: 407th Sapper Bn from Gia Lai Province Committee to MR 5.

(5) Significant Enemy Tactics and Techniques. This quarter saw the long awaited Communist Winter/Spring Offensive on 21-22 Feb. The suspected first phase was dominated by standoff attacks coupled with limited ground action against selected Allied forces and installations and hamlets. A prime target was the pacification campaign and associated programs; most notable were atrocities in two hamlets of Kontum Province. Throughout the Corps, the enemy

CONFIDENTIAL

2

INCL

CONFIDENTIAL

AVFA-CC-01

15 May 1969

SUBJECT: Operational Report of Headquarters, I FFORCE/ for quarterly
Period Ending 30 April 1969 RCS CSFOR-65 (R1) (U)

attempted to terrorize the population; in several areas GVN officials were assassinated. Highly significant during the offensive was the enemy's use of tanks and large caliber artillery in the highlands. During the last month of the period, there was a considerable reduction in enemy activity with reports of several major units withdrawing to sanctuary. At the close of the period, two significant items were reported. First was the presence of infiltration groups in the highlands apparently destined for the coastal area and the possible identification of a new regiment in the highlands. Secondly, reports indicate that the Communists are preparing for a Summer Offensive to be conducted in May or June.

(4) Enemy Losses and Strengths.

(a) Enemy losses during the period (DOW is 35% of KIA).

MONTH	KIA	DOW	PW	HOI CHANH (Military)	SA	C/S
Feb	1801	630	148	45	530	68
Mar	2353	824	169	116	724	73
Apr	1555	544	137	77	620	41

(b) Enemy strengths at the beginning and end of the quarter.

	1 Feb 69	30 Apr 69
NVA	15,195	11,345
LF/MF	8,860	10,310
Admin	5,375	5,275
Guerrilla	15,940	13,000
Infrastructure	<u>17,800</u>	<u>14,300</u>
TOTAL	63,170	54,230

The decrease in enemy strength during the quarter is attributed to the enemy's redistribution of major units to II Corps, combat losses, and improved reporting procedures.

(5) Enemy Capabilities, Vulnerabilities and Probable Courses of Action.

(a) Capabilities:

1. In Kontum Province, the enemy has the capability to:

a. Conduct standoff attacks or combination standoff/sapper attacks against US/Allied installations and Kontum City, employing mortars of up to 120mm, 75mm RR and rockets of up to 122mm.

b. Employ 85mm/100mm/105mm artillery against installations up to 40 km from the Cambodian border.

CONFIDENTIAL

INCL

CONFIDENTIAL

AVFA-GC-OT

15 May 1969

SUBJECT: Operational Report of Headquarters, I FFORCEV for quarterly Period Ending 30 April 1969 RCS CSFOR-65 (R1) (U)

a. Conduct ground attacks against friendly installations in up to multi-battalion strength supported by standoff fires and limited armor in the vicinity of Plei Kleng and Ben Het.

d. Interdict Highways QL 14N and 12, as well as other friendly LOCs.

e. Restrict friendly air activity with fire from SA, AW, 12.7mm, 14.5mm and 37mm AA weapons.

2. In Pleiku Province, the enemy has the capability to:

a. Conduct selective attacks on Pleiku City, Plei Diereng, Plei Me, Plei Nhung, Duc Co CIDG camps or Edap Enong, Thanh An and Le Trung; in reinforced battalion strength, supported by mortar, rocket, RR and 105mm artillery fire.

b. Attack Pleiku City, US/ARVN bases, CIDG camps, district headquarters and resettlement areas, using 82mm mortar, RR and 122mm rocket fire and sappers.

c. Employ battalion size NVA/VC forces against friendly convoys and installations along QL 19E and QL 14, supported by 75mm RR and 60mm/82mm mortar fire.

d. Attack LOCs 509, TL6C, 437, TL7C and LTL7B with company size VC element using anti-tank grenades, RR and mortar fire.

e. Employ limited armor (possible) and artillery in the Duc Co vicinity.

3. In Darlac Province, the enemy has the capability to:

a. Attack the district headquarters of Buon Ho and Lac Thien and isolated hamlets in up to reinforced battalion strength.

b. Conduct ambushes and harassing activities along QL14 and 21.

c. Attack Ban Me Thuot City with a multi-battalion force employing 75mm RR, 60mm/82mm/120mm mortars and 122mm rockets.

d. Strike selected targets in northern Darlac with multi-battalion force now infiltrating through area.

4. In Quang Duc Province, the enemy has the capability to:

a. Attack the Duc Lap area with a multi-battalion size force.

b. Conduct attacks by fire and limited ground attacks at Gia Nghia and Nhon Co.

c. Attack Bu Prang CIDG Camp with a battalion size force.

5. In Lam Dong and Ninh Thuan Provinces, the enemy has the capability to:

a. Conduct attacks by fire on Allied installations and hamlets in up to battalion strength.

CONFIDENTIAL

CONFIDENTIAL

AVFA-CC-OT 15 May 1969
SUBJECT: Operational Report of Headquarters, I FFORCEV for quarterly
Period Ending 30 April 1969 RCS CSFOR-65 (R1) (U)

- b. Attempt interdiction of QL 11 and QL 20.
 - c. Attack Phan Rang Air Base with 107mm/140mm rockets.
 6. In Tuyen Duc Province, the enemy has the capability to:
 - a. Conduct standoff and sapper attacks against US and GVN installations.
 - b. Attack these installations in up to battalion strength.
 7. In Binh Thuan Province, the enemy has the capability to conduct attacks by fire, attack hamlets and allied installations in up to multi-battalion strength.
 8. In Khanh Hoa Province, the enemy has the capability to:
 - a. Conduct company size attacks against lightly populated areas.
 - b. Conduct sapper/swimmer attacks against lightly populated areas.
 9. In Phu Yen Province, the enemy has the capability to:
 - a. Attack population centers and Allied installations in reinforced battalion strength.
 - b. Conduct standoff attacks, terrorist and sapper attacks against friendly controlled areas.
 - c. Restrict movement along LOCs.
 10. In Phu Bon Province, the enemy has the capability to conduct company size attacks against Cheo Reo and district headquarters.
 11. In Binh Dinh Province, the enemy has the capability to:
 - a. Attack population center, US/GVN/ROK installations and units in multi-battalion strength.
 - b. Restrict movement of QLS 1 and 19 by employing mines or conducting standoff attacks and raids against friendly convoys and installations on and along the highways.
 - c. Conducting sapper and terrorist activities against installations along the coast.
 12. Throughout II Corps, the enemy has the capability to:
 - a. Employ chemical agents, by various delivery systems, during any attack.
 - b. Withdraw forces to base areas and sanctuaries for replacements, resupply and retraining.
 - c. Enter outlying villages to conduct propaganda lectures, recruit personnel, impress civilians as laborers/porters and to obtain provisions and information.

CONFIDENTIAL

CONFIDENTIAL

AVFA-GC-OT

15 May 1969

SUBJECT: Operational Report of Headquarters, I M'ORCEV for Quarterly Period Ending 30 April 1969 RCS CSPOR-65 (R1) (U)

d. Continue disruption of the GVN nation-building effort by assassinations, kidnapping and other terrorist acts.

e. Establish limited political entities, i.e., liberation councils and committees in contested and VC controlled areas.

f. Reinforce with reserves located in sanctuaries in the Cambodian, Laotian, I CTZ and III CTZ border areas. Some enemy units which are currently active in I CTZ and III CTZ could be expected to redeploy to II CTZ, if the enemy shifts of interest to II CTZ. Size of reserves or reinforcement in sanctuaries is not known.

g. Employ combinations of the above capabilities.

(b) Vulnerabilities:

1. Enemy supply areas are generally insecure, rendering supply caches vulnerable to friendly search and destroy operations.

2. The enemy's limited capability to support offensive operations for extended periods makes him vulnerable to superior Allied firepower when massed in attack positions, at the objective and during withdrawal.

3. Low morale exists in many units owing to food shortages, sickness, heavy losses and continuing defeats. The enemy is susceptible to friendly psychological operations.

4. Enemy reliance on local civilians as a labor source makes larger operations vulnerable to friendly intelligence efforts.

(c) Probable Courses of Action:

1. The enemy's most probable course of action in the next quarter is to conduct a series of Corps wide coordinated attacks in conjunction with a Summer Offensive phase. It is expected that this offensive will be similar to the offensive initiated on 22-23 Feb, although it is possible that more ground attacks may be mounted because of apparent reinforcement. Until such time as the Summer Offensive is initiated, the following probable courses of action are valid.

2. In Kontum Province, likely courses of enemy action include a resumption of attacks by fire, as well as continuation village harassment and mining, though a low level of activity is anticipated.

3. In Pleiku Province, the enemy will most probably continue a low level of activity, though an increase in standoff attacks may be seen in the vicinity of Pleiku City.

4. In Darlac Province, likely courses of enemy action should include a low level of activity with attacks by fire predominating and continuing contact along the northern infiltration route between Dieu Ajar and Buon Blech CIDG Camps.

5. In Quang Duc Province, the most probable course of enemy action will be to continue a low level of activity and avoid contact with friendly forces operating in the province.

CONFIDENTIAL

CONFIDENTIAL

AVFA-CC-OT

15 May 1969

SUBJECT: Operational Report of Headquarters, I FFORCEV for quarterly Period Ending 30 April 1969 RCS CSFOR-65 (R1) (U)

6. In Lam Dong Province, the VC will probably continue attacks by fire on RF/PF defenses and GVN installations as well as terrorism directed at weakening government control, employing action arrow teams and local forces in up to reinforced company strength.

7. In Tuyen Duc, the enemy can be expected to continue with terrorist activity, standoff attacks on US and GVN installations, as well as limited ground attacks of reinforced platoon to reinforced company size.

8. In Binh Thuan Province, although the enemy retains the capability of massing several battalions, he will probably continue to attack by fire and ambush, employing forces up to reinforced battalion size. Smaller forces, however, should be the rule. Enemy targets will continue to be RF/PF defenses and province and district headquarters, with US and ARVN forces coming under attack when reconnaissance indicates defenses are relaxed.

9. In Ninh Thuan Province, it is likely that VC forces will continue standoff attacks, terrorism and sabotage within their capabilities, committing forces in platoon to company strength.

10. In Khanh Hoa Province, the enemy's most probable course of action is to avoid contact except to conduct an infrequent attacks by fire on an airbase or attempt sabotage of port and logistical facilities.

11. In Phu Yen Province, the enemy's most probable course of action is to conduct small-scale harassing and terrorist attacks in conjunction with periodic road and railway interdiction. Installations in the Tuy Hoa area, Phu Hiep and Vung Ro Bay are possible targets for enemy sappers and artillery attacks.

12. In Phu Son Province, the enemy's most probable course of action is to target district headquarters and isolated installations by utilizing ~~large~~ scale ground and standoff attacks. Cleo Reo Airfield remains the most lucrative target.

13. In Binh Dinh Province, the enemy is expected to select as his primary objective, disruption of the GVN pacification effort. In addition, his course of action is expected to direct attention at interdiction of QL 19 and the targeting of selected highly sensitive items such as ammunition and POL storage areas and aircraft.

(6) Significant Sources, Agencies and Techniques:

(a) Changes in Sources, Agencies and Techniques. A continued improvement in intelligence collection and reporting of political, infrastructure, Local Force, and guerrilla related information has been noted since the implementation of the BIG MACK Intelligence Collection Program in the last period. In most cases, this improvement of the collection program has kept pace with the increasing emphasis placed upon these enemy elements influencing the pacification campaign.

(b) G2 Air:

1. Beginning in Feb, the G2 Air, through the 225th Surveillance Airplane Co, made a Monawk available on a daily basis to the 4th Inf Div, 175th Abn Bde and to Task Force South to provide these units the capability of visual reconnaissance with photo backup. This is the most responsive photographic system available in II CZ. The concept of the system is as follows:

CONFIDENTIAL

CONFIDENTIAL

AVFA-GC-01

15 May 1969

SUBJECT: Operational Report of Headquarters, I FFORCEV for Quarterly Period Ending 30 April 1969 RUC CSOR-65 (R1) (U)

a. Each morning at approximately 0800 hours, a Mohawk Aircraft lands at an airfield which services these units. A representative of the G2 Air Section briefs the pilot and observer of the areas to be covered. While the VR Mission is being flown, the pilot photographs any items of military significance.

b. After completion of missions in the 4th Inf Div area, the pilot is debriefed immediately at the 4th Inf Div and the film from the mission is developed by the 4th Inf Div Photo Reproduction Section, after which it is interpreted by its Imagery Interpretation Section.

c. After completion of missions in the 173d Abn Bde area and Task Force South area, the pilot returns the film to the 225th Surveillance Airplane Company at Phu Hiep where it is developed and interpreted immediately after delivery. The Imagery Interpretation Reports and the photography, when required, are delivered to these units by the aircraft which reports for missions the following day. Because of the loss of an aircraft in March, it became necessary to use one aircraft between the 173d Abn Bde and Task Force South; these units receive the aircraft on alternate days.

2. During the reporting period, the 4th Inf Div received an ES-38 Laboratory Darkroom, which gives it the capability to process all types of aerial imagery. This further increases the responsiveness of aerial surveillance and reconnaissance for the 4th Inf Div.

3. In response to enemy attacks and threats along the border in II CTZ during the quarter, the G2 Air tasked the 225th Surveillance Airplane Co to provide maximum SLAR coverage in the area concerned in an effort to detect enemy vehicular movement. This intensified SLAR Program provided 18 hours of SLAR coverage per day. The number of moving target indicator detections increased significantly, but analysis revealed that most of these were friendly. As the threat decreased, the intensified SLAR Program decreased correspondingly so that by mid-April, SLAR coverage along the border reverted to normal operations.

4. During the last month of the reporting period, Task Force South was provided an operational Infra-Red Ground Sensor Terminal Team which gives it, along with the 4th Inf Div and the 173d Abn Bde, the capability to receive instantaneous infra-red detections upon which it may respond with immediate artillery strikes.

5. The G2 Air concentrated the preponderance of its aerial reconnaissance and surveillance assets along three known or suspected infiltration routes to determine enemy movement, assembly areas, defensive positions and trail activity.

a. Seven provinces were tasked to provide continuous VR coverage from sunrise to sunset, weather permitting, of these infiltration routes. Twenty five aircraft from the provinces, supplemented by I FFORCEV Artillery O-1 Aircraft, were committed to the task.

b. Mohawk Infra-Red Missions were scheduled twice a day along these infiltration routes. These missions were scheduled to coincide with the time that "Shadow" Aircraft were also scheduled in the area to permit immediate response by "Shadow" to infra-red detections acquired by the Mohawk Aircraft.

CONFIDENTIAL

CONFIDENTIAL

AVFA-GC-01

15 May 1969

SUBJECT: Operational Report of Headquarters, I FFUKCV for Quarterly Period Ending 30 April 1969 RCS CSFOR-65 (R1) (U)

c. Two Mohawk infra-Red Aircraft were converted to photo aircraft specifically to provide additional visual reconnaissance with a rapid photo backup response. These aircraft also provide continuous daylight coverage.

d. Air Force Photo Missions were scheduled in the area to provide complete photo coverage of the routes.

e. SLAR coverage along the border contiguous to these areas were also scheduled twice a day.

6. During the last month of the quarter, the G2 Air conducted a two day conference at the 225th SAC, Phu Hiep, for C2/S2 Air Officers and Advisors in II CTZ. Eighteen persons, to include one ARVN and two ROK representatives, attended the conference. The purpose of the conference was to present a thorough briefing on the complete aerial surveillance and reconnaissance program in II CTZ, to familiarize the representatives with capabilities and limitations of Army and Air Force sensor systems available, and to correct or recommend solutions to existing problems.

7. During the period 1 Feb through 30 Apr, a total of 10,424 VR sorties were flown with an average of 42 aircraft. The VR missions resulted in a total of 48 airstrikes, 142 artillery missions and 130 ground actions in II CTZ. There were also 1,148 photos, 5,147 infra-red, and 8,353 SLAR Target areas planned. Results from completed missions were furnished to commanders concerned.

(c) G2 Collection.

1. During the first quarter of 1969, the G2 Collection Division conducted an accelerated Volunteer Informant Program campaign. This campaign included G2 representation at a Province Seniro Advisors Conference in Nha Trang, a Phoenix Coordinators meeting in Nha Trang, and a Province Intelligence Advisors Conference in Pleiku. Written guidance has been provided to the field, and personal visits made by G2 Collection persone. This increased emphasis has yielded a three-fold increase in the program's effectiveness. The accelerated program continues, and the level of response is expected to grow.

2. Three times during the quarter, G2 Collection conducted combined exploitation operations with MACV J2 elements. These combined efforts are a new venture and have produced quality intelligence in a timely manner. Continued cooperation in the utilization of IFFV and MACV document and PW "Go Teams" is expected to produce more thorough and current intelligence in the future.

3. Approval has been obtained from MACV to obtain 3M Document Reproducing machines for Sector S2's. These machines are currently being ordered and will enable copies to be made of captured documents which in turn will allow simultaneous local exploitation of the document and evacuation to the Combined Document Exploitation Center in Saigon.

4. The Combined Interrogation Center in Pleiku opened during the quarter and is the greatest source of combined intelligence production in II CTZ. The ARVN element has assumed a role of dynamic leadership at the Center, and the cooperation between US Army, US Air Force, ARVN and ROK elements is gratifying.

CONFIDENTIAL

CONFIDENTIAL

AVFA-GC-01

15 May 1969

SUBJECT: Operational Report of Headquarters, I FFORCEV for Quarterly Period Ending 30 April 1969 RCS CSFOR-65 (R1) (U)

(d) Det D, 1st MI Bn (ARS):

1. During the period 1 Feb 69 through 30 Apr 69, Det D flew sorties in support of units of the II CTG, transporting 13,240 pounds of cargo. The detachment interpreted 2,135 targets (636,802 prints), and prepared 2,125 II Reports which contained 2,898 items of significance. The reproduction section processed 197,200 feet of paper to meet the requirements of 550 reproduction request.

2. Hand-held photographic missions continued to receive emphasis within the Detachment's overall operations. It flew hand-held missions resulting in 7923 developed prints.

3. During the period, Det D, 1st MIBARS conducted hand-held photography courses each month. Thirty personnel, to include three ARVN and four BOK, attended the two day course of instruction at Nha Trang.

(e) 55th MI Det (CORPS).

1. For the period 1 Feb 69 through 27 Apr 69, the 55th MI Det, II Section received 418 in-country missions and processed 263. In addition, 30 Dorsal Fin and French Leave Missions were processed. A total of 20 Special Photo Interpretation Reports were submitted which included 18 area studies in RVN, one trafficability study and one area study in Southeastern Laos. Fifteen Supplementary Photo Interpretation Reports were also submitted covering the Dorsal Fin and French Leave area.

2. In addition to reports submitted, the following accomplished by this section:

a. Continued three area studies covering approximately 16,465 square km.

b. Interpreted numerous missions covering the NVA Road Network and Border Area, and provided current information on these areas to the G2 Air and 64th Eng Det (T).

c. Furnished the 64th Eng Det (T) with updated master plates covering the II Corps Tactical Zone.

d. Constructed six mosaics for requestors.

e. Briefed two visitors and conducted two liaison visits during the quarter.

3. During the period 1 Feb 69 - 30 Apr 69, all captured weapons and materiel were processed and evacuated through S4/G4 channels. During the period, IPW screened and classified 266 detainees, and as a result of these interrogations a total of 55 PIRs and IRs were produced and distributed. Captured documents were screened and 41.5 feet of documents were screened and 41.5 feet of documents were forwarded to CDEC for further exploitation. IPW teams translated a total of 173 enemy documents.

CONFIDENTIAL

CONFIDENTIAL

AVFA-GC-OT

15 May 1969

SUBJECT: Operational Report of Headquarters, I FFORCEV for Quarterly Period Ending 30 April 1969 RCS CSFOR-65 (R1) (U)

(f) Co C (Ranger), 75th Inf

1. On 9-10 Apr, Co C (Ranger), 75th Inf participated in the USARV Long Range Patrol Commanders' Conference held at the MACV Recondo School in Nha Trang. The conference reiterated those tactics and techniques for the employment of long range patrols that have proven successful in the Republic of Vietnam. Several items of new and development equipment were also demonstrated. The conference continued on the second day with a discussion of the techniques that the various units are experimenting with and the problem areas affecting their maximum utilization. The conference terminated with presentations by representatives from ACTIV, USACDC, and MACSOG on subjects of mutual interest and assistance.

2. During the reporting period, Co C (Ranger), 75th Inf completed the construction of the necessary training facilities to conduct basic and refresher long range patrol training at its base camp in An Khe. This facility will allow the company to complete adequate Pre-Recondo training prior to sending the newly assigned personnel to the MACV Recondo School at Nha Trang. A three-week refresher course designed to strengthen 21 personnel that had not previously undergone any LRP specialized training terminated on 22 Apr 69. Physical conditioning, communications, map reading, advanced first aid, and heliborne techniques were emphasized during this course of instruction.

3. The company received six National Match M-14 rifles with telescopic sights during March. With training assistance from the 4th Inf Div, personnel from Co C are now being trained in sniper techniques and marksmanship to give the teams a sniper capability.

4. During the reporting period, the company conducted operations in five separate areas. From 4 Feb through 22 Feb 69, the company minus one platoon supported the 9th ROK Inf Div in the Ha Roi area. From 26 Feb through 8 Mar, the company minus two platoons supported the Phu Bon Province Senior Advisor with operations in an AO in northern Phu Bon and southern Binh Dinh Provinces. From 9 Mar through 28 Mar operations were conducted along the known infiltration routes in southwestern AO HINES in support of the 4th Inf Div. Since 29 Mar, the company has supported the 173d Abn Bde in northern Binh Dinh Province, AO LES. Throughout the reporting period, one or two platoons have been available to the 173d Abn Bde at An Khe for operations targeted against enemy elements in the vicinity of Highway 19 from An Khe to the Mang Yang Pass.

(g) The 64th Eng Det (T):

1. Compiled and overprinted approximately thirty 1:100,000 scale maps sheets with mining and highway incidents throughout II CTZ. Distribution of this study was completed during the period.

2. The unit assembled the necessary cut-out maps of each district within II CTZ to prepare seven briefing booklets for the Command Section. The map cut-outs were labeled with the district names and mounted in plastic suitable for binding in loose leaf form.

3. Continued production of Terrain Studies in anticipation of future tactical operations.

CONFIDENTIAL

CONFIDENTIAL

AVFA-CC-OT

15 May 1969

SUBJECT: Operational Report of Headquarters, I FFORCEV for Quarterly
Period Ending 30 April 1969 RCS CSFOR-65 (R1) (U)

4. Provided G2 representative, 4th Inf Div with information required for CG's briefing in regard to a brigade operational move.

5. Developed study depicting railroad information to include alignment and bridge location for II CTZ. Information was presented as overprinted data on eleven 1:100,000 scale maps.

(h) Det 31, 5th Weather Squadron

1. Det 31, 5th Weather Squadron has the mission of supporting I FFORCEV and USARV tactical units in the II Corps area. Support is being provided in the following manner.

a. I FFORCEV: Staff Weather Officer, Forecast Support Center for II Corps, Climatological Support, and Mobile Observation Teams.

b. 4th Inf Div: Staff Weather Officer and Forecaster Support at Base Camp, Observations at Brigade Tactical CPs, Observations at Base Camp, and Climatological Support.

c. An Khe: Observation and forecasts as required.

d. Dalat (Cam Ly Airfield): Observations and forecasts as required.

e. English Air Field: Observations and forecasts as required.

f. Phan Thiet: Observations and forecasts as required.

2. Det 31 hosted a conference, on 25 - 26 Apr, for the 1st Weather Group Staff, 5th Weather Squadron Staff and all 5th Weather Squadron Detachment and OL Commanders. Progress was made towards the conference goals of increased weather support for all USARV units.

(7) Deviations from Current Intelligence Doctrine: None.

(8) Recommendations of New Techniques and Changes in Doctrine and/or Organization: None.

(9) Comments and Explanation of Significant Changes in Variance with the Previous Report: None.

(10) Weather:

(a) General: Light to moderate northeast flow dominated the weather pattern over II Corps, with occasional strong northeasterly flow morning over the coast from February through March. The flow during late March was light and variable from the southeast and southwest, except during the week 30 Mar - 5 Apr when a new surge from the northeast moved over the coast of II Corps.

(b) Coastal: Variable weather dominated the period along the coast as occasional northeast monsoonal surges moved over the coast from February to the first week in April. Weather along the coast was generally fair to partly cloudy, except on 21 - 22 Feb when skies

CONFIDENTIAL

CONFIDENTIAL

AVFA-CC-01

16 May 1969

SUBJECT: Operational Report of Headquarters, I MFCORCEV for Quarterly Period Ending 30 April 1969 RCS CSFOR-65 (R1) (U)

was cloudy all day with occasional light rain and rainshowers and extended as far south as Nha Trang. By late March and April, most rainfall occurred in the form of thunderstorms and rainshowers. Most activity occurred north of Tuy Hoa. Patchy low clouds, fog and haze in the river and mountain valleys restricted visibilities on most mornings until 0900H. A heavy haze layer from surface to near 10,000 feet hampered air operations on most mornings during the period. Visibilities were unrestricted, except in fog, haze and in shower activity. Mountain tops above 2000 feet were obscured on most mornings. Rainfall amounts along the coast were normally less than three inches, except Tuy Hoa which reported 4.95 inches during the period, with 4.15 inches occurring on 5 Apr.

(c) Interior: Skies were fair to partly cloudy to occasionally cloudy with rainshowers and thunderstorms occurring during the afternoon and early evening hours. The heaviest shower activity occurred over the southern and northern highlands during the months of March and April. The heaviest thunderstorm during the period occurred at Pleiku on 21 Mar, where two inches of rainfall fell, hail and gusts to near 35 knots occurred in less than one hour. Extensive low clouds, fog and haze restricted visibilities on most mornings to less than three miles. The lowest conditions occurred over the southern highlands, where visibilities were near zero at sunrise. Surface winds were northeasterly to easterly at 10 to 15 knots during day in the months of February and March and light and variable at night. The surface winds shifted to a southeasterly to southwesterly direction during the latter part of March. Wind speeds were generally five to 10 knots, except gusting to near 40 knots in heavier thunderstorms.

(d) Effects on Operations: There were a total of 252 TAC sorties cancelled due to weather from 1 Feb through 30 Apr 69. No other effects are known.

c. (C) Operations and Training Activities.

(1) Plans: During the reporting period, two OPLANS, one LOI, one Staff Memorandum, a special edition of Tactical Notes on Cover and Deception, Annex T (Measurement of Progress) to the II CTZ Combined Campaign Plan, 1969, and a Combined Letter of Promulgation on the Military Support of Pacification were published. In addition, two studies were completed, an Operational/Pacification Analysis and a Road Security Study of II CTZ. Two Combined Commanders' Conference and one US Senior Commanders' Conference were held.

(a) Plans:

1. OPLAN 102-69 (Project SONJIA) was published on 28 Mar 69. Further discussion of the OPLAN is precluded by the classification of this report.

2. OPLAN 103-69 (WASHINGTON GREEN) was published on 13 Apr 69 and implemented on 15 Apr 69, as Operation WASHINGTON GREEN.

a. WASHINGTON GREEN is a long term integrated effort by ROK, ARVN and US regular forces operating in concert with RF/PP, PSDP, National Police, Province Reconnaissance Units, CIDG, MSP and GVN agencies.

CONFIDENTIAL

CONFIDENTIAL

AVFA-GC-07 15 May 1969
SUBJECT: Operational Report of Headquarters, I FFORCEV for Quarterly
Period Ending 30 April 1969 RCS CSFOR-65 (R1) (U)

b. Goals of the campaign are achievement of revised 30 Jun 69 Pacification Goals to upgrade 114 hamlets, destruction of the VCI, guerrillas and sapper elements and to set the stage for resettlement.

c. ARVN and FWMAF will provide security for the GVN pacification effort, with primary emphasis given to village and hamlet protection. Territorial forces, in conjunction with other GVN agencies, will actively conduct the pacification effort behind the shield provided by regular forces. Allied forces will continue security missions for the period of time required to insure protection of the GVN pacification effort.

d. A primary target is the destruction of the VCI, the guerrilla and sapper-terrorist elements. Reaction to VCI/NVA efforts to disrupt the campaign is an essential factor of contingency planning.

e. Internal areas of operation have been realigned to coincide with district boundaries. Combat operations are focused at the district level. Whenever possible, battalion command posts are co-located with district headquarters. Military operations are planned to support the district pacification program.

f. OPLAN 103-69 concentrates three infantry battalions and one mechanized battalion of the 173d Abn Bde in the four highly populated northeastern coastal districts of Binh Dinh Province. The eastern boundary of the 4th Inf Div was extended to include An Tuc and the northern half of Binh Khe District.

(b) LOIs:

1. LOI 7-69 (SPRINGRAY CONCEPT) was published on 3 Mar 69. Further discussion of this LOI is precluded by the classification of this report.

2. Combined Letter of Promulgation on the Military Support of Pacification was published on 28 Feb 69. This letter promulgates the agreement made by CG, II Corps, DCG, ROKFV-FC, and CC, I FFORCEV to adopt procedures for a greater degree of coordination between ARVN/ROK/US regular forces and the provinces/sectors in II CTZ. By direction of CG, II Corps, each sector commander in II CTZ is required to conduct a monthly meeting with the senior officer of ARVN and FWMAF tactical commands within the sector. The purpose of these meetings is to discuss military support of pacification, to coordinate military civic action programs, to identify problem areas and to determine operations by which tactical commanders can assist the sector commanders in the rapid attainment of pacification goals. This combined letter directs all subordinate commanders in II CTZ to be responsive to calls for meetings by the sector commander, and consistent with the tactical situation and available assets, provide all possible assistance in meeting the requests of the sector commanders. In order to monitor the progress of these meetings and keep abreast of support requested and provided, the combined commanders are each provided with a resume within ten days after the meeting is held.

CONFIDENTIAL

CONFIDENTIAL

AVFA-CC-OT

15 May 1969

SUBJECT: Operational Report of Headquarters, I FFORCEV for Quarterly Period Ending 30 April 1969 RCS CSFOR-65 (R1) (U)

(c) Combined Campaign Plans:

1. Annex 7 (Measurement of Progress) to the II CTZ Combined Campaign Plan, 1969 was published on 8 Mar 69. This annex contains the II CTZ Combined Campaign Goals for 1969, its indicators which will be used to measure and report progress toward their achievement and guidance for the preparation and presentation of the combined Quarterly Reviews.

2. The Quarterly Summary of Progress toward achievement of CCP goals was submitted to MACV on 16 Apr 69. The formal Quarterly Review was presented to the COMUSMACV and the Chief, JGS, RVNAF at II Corps, Headquarters in Pleiku on 29 Apr 69.

3. Staff Memo 10-8, Preparation of Campaign Plans, Periodic Summaries and Reviews was published on 24 Feb 69. It outlines the I FFORCEV "in house" procedures and responsibilities for the preparation of the Combined Campaign Plan and Quarterly Review and specifies the format to be used in the preparation of the written Quarterly Summary.

(d) Studies:

1. An Operational/Pacification Analysis of II CTZ was prepared and published on 11 Apr 69. The analysis covered the 14 month period from 1 Feb 68 to 1 Apr 69. Further discussion of this analysis is precluded by the classification of this report.

2. A Road Security Study of the major LOCs in II CTZ was completed on 28 Apr 69. The purpose of this study was to determine how to maintain II CTZ roads in an open, more secure condition, with reduced expenditure of security forces. It included a detailed analysis of enemy actions directed against these LOCs from 1 Jan 69 to 18 Apr 69. Friendly activities to counter these enemy actions were also studied with a view toward evaluating their adequacy. This included friendly forces contributing to LOC security, convoy security measures, artillery coverage, Rome Plow and clearing operations, the use of defoliants and the relationship of the pacification effort as a contributing factor. As a result of this analysis, recommendations were made for the reclassification of the security status of several major LOCs, the redistribution of security forces and specific areas identified for intensifying friendly operations against enemy road interdiction forces.

(e) Other: Special Edition of Tactical Notes on Cover and Deception was published on 15 Mar 69. The purpose of these tactical notes is to develop a greater understanding and wider application of Cover and Deception techniques in support of military operations. Included are a discussion of the target for our Cover and Deception efforts - the enemy- and methods that pertain to various type units.

(2) Summary of Ground Operations:

(a) Western Highland Operations February: Activity in the three Highlands Provinces continued to be heavy. Activity in Western Pleiku and West and Northwestern Kontum Province was characterized by large scale ground and standoff attacks against allied forces, installations and civilian population centers. Enemy activity in the Ban Het - Cambodian border and Poley Kleng CIDG Camp areas reached the highest level of intensity for the year to date.

CONFIDENTIAL

CONFIDENTIAL

AVFA-GC-OT

15 May 1969

SUBJECT: Operational Report of Headquarters, I FFOURBV for Quarterly Period Ending 30 April 1969 RCS CSFOR-65 (R1) (U)

1. US Operations: Operation GIBBEN THUNDER continued into February. On 6 Feb, Co C, 1st Bn, 12th Inf position (YA904665), west of Plei Mrong, was attacked by an estimated two reinforce enemy squads resulting in US casualties of one KIA and 13 WIA. On 8 Feb, Co C, 1st Bn, 14th Inf, discovered a grave site (YA941684) containing 24 NVA bodies. In the same area on 9 Feb, elements of Co B, 1st Bn, 12th Inf, Co B, 1st Bn, 14th Inf, and Co B, 3d Bn, 12th Inf, killed ten enemy while losing six friendly KIA and five WIA. On 11 Feb, vicinity YA940681, Co B, 1st Bn, 14th Inf, received heavy fire and engaged the enemy force with support from gunships, tactical air and artillery. Friendly losses were two KIA and 17 WIA. Enemy losses were 43 KIA. US air strikes on enemy locations resulted in 49 secondary explosions. Five km east (YA899680 and YA905673), Co C, 1st Bn, 12th Inf, found two large weapons caches on 12 Feb which contained two 122mm rockets, 188 rounds of 60 and 82mm mortar, 23 rounds of 75mm RR, an estimated 27,000 rounds SA ammunition, 40 M79 rounds, seven B40 rockets and three cases of C4. The operation terminated on 17 Feb. Friendly losses were 20 KIA, and 50 WIA. Enemy losses were 106 KIA, two 122mm rockets, 19 82mm mortar rounds, 270 60mm mortar rounds, 23 75mm RR rounds, 34,500 rounds SA, 44 B40 rockets, 40 40mm rounds, 935 CS rounds captured, 40 structures and 25 fortifications destroyed. During the month, other operations were conducted as indicated: Operation GREENE BLUE was conducted 1-25 Feb with 2d Bn, 35th Inf constructing FSB Fighter vic AQ8540. Friendly losses were two KIA, and eight WIA. Enemy losses were one PW, 42 Detainees, and two SA CIA. Operation WAYNE GREEN was conducted 11-28 Feb with 1st Bn, 8th Inf, 3d Bn, 8th Inf, 3d Bn, 12th Inf, and 2d Bn, 8th Inf (Mech), vic AR9171. Friendly losses were one KIA, and 14 WIA; Enemy losses were 15 KIA, two PW, five Detainees, seven SA and three CSW CIA. Operation PUTNAM PANTHER was conducted 1-28 Feb with 1st Bn, 12th Inf, 1st Bn, 14th Inf, and 1st Bn, 22nd Inf, vic ZA0090. Friendly losses were three KIA, and 24 WIA. Enemy losses were 12 KIA, two PW, 28 Detainees, six SA and one CSW CIA. During the period, elements conducted ten cordon and search operations resulting in 22 blacklist VCI captured. In other US actions, Kontum AF received 17 rounds of 122mm rockets on 23 Feb resulting in four civilians wounded, four aircraft and three trucks damaged. Again on 24 Feb, Kontum AF received five 122mm rockets with 18 more landing in the immediate area resulting in two US WIA, one aircraft destroyed and two damaged. On 28 Feb, C Co, 1st Bn, 35th Inf received 30 rounds of 60mm mortar in their night location (ZA062533) which resulted in 31 WIA.

2. ARVN Operations: On 1 Feb, 19 km West of Plei Mrong (vic YA935674), 1st Bn, 47th ARVN Regt in Operation BINH TAY 50, killed 55 enemy and captured three SA, two CSW, and four B41 rocket rounds in two contacts. Friendly losses were 10 KIA, 90 WIA, and three MIA. On 3 Feb, 19 km West of Plei Mrong, elements of the 4th Bn, 42d ARVN Regt, in Operation BINH TAY 50 found an arms cache (YA930680) containing 144 rounds of B40 rocket, 100 charges for B40 rockets, 186 rounds of 60mm mortar, six rounds of 82mm mortar, eight 82mm mortar fuzes, five SA, 700 rounds of SA ammunition, and a small amount of miscellaneous equipment. On 22 Feb, 13 km NW of Pleiku (ZA123524), elements of the 11th ARVN Ranger Bn were attacked by an estimated enemy platoon resulting in nine KIA and three WIA. Enemy losses were unknown. On 23 Feb, 13 km West of Pleiku, the 11th ARVN Ranger Bn found 15 bodies in a fresh grave (ZA129512), estimated to be 24 hours old. On 24 Feb, three km East of Pleiku (AR790465), the 422d ARVN Eng Co received an unknown number of mortar rounds resulting in one KIA and 10 WIA. On 25 Feb, 13 km SE of Dak To (ZB119171) elements of 4th Bn, 42d ARVN Regt, made contact with unknown number of enemy resulting in 24 friendly WIA (one US). Enemy had

CONFIDENTIAL

CONFIDENTIAL

AVFA-GC-OT

15 May 1969

SUBJECT: Operational Report of Headquarters, I FFORCEV for Quarterly Period Ending 30 April 1969 KCS CSFOR-65 (R1) (U)

eight KIA and lost two SA. Nineteen km NNW of Pleiku (ZA1966), elements of 3d ARVN Cav Regt received an unknown number of mortar rounds. Artillery supported. Friendly losses were two WIA. Enemy losses were 40 KIA, four PW, seven B40 rockets, 17 AK47's, one 60mm mortar, and one SA CIA. On 26 Feb, 24 km NW of Pleiku (ZA165702), elements of the 1st Bn, 42d ARVN Regt, engaged an estimated enemy platoon. Artillery and gunships supported. Results were two ARVN KIA and two ARVN WIA while enemy suffered 18 KIA and three SA captured.

3. CIDG Operations: On 10 Feb, 45 km SE of Ban Me Thuot (BP196843), the 232d MSF Co, operating in the Buon Mi Ga, found a base camp with a blacksmith shop, ten huts and a small amount of munitions. On 11 Feb, nine km SW of Dak Pek (YB881644), a CSF patrol from Dak Pek CIDG Camp spotted an estimated enemy battalion digging in and contacted a FAC. The FAC directed air strikes resulting in 20 enemy KIA (FAC confirmed). On 17 Feb, 33 km NE of Lac Thien (BP295849), the 233d MSF Co found a forced labor camp constructed on approximately 15 Feb. Fifteen pounds of documents were found depicting plans for tactical operations and pictures. Two civilian radios, two flags, medicine, and sugar were captured. One grave found at the site contained one NVA body. On 21 Feb, 22 km NW of Plateau Gi (AS889299), 213d MSF Co discovered a 1500 pound rice cache. On 23 and 24 Feb, Ben Het CIDG Camp (YB873257) received over 310 rounds of 82mm mortar, 100mm artillery and 122mm rocket resulting in one KIA and three WIA. On 23 Feb, 17 km SSW of Ban Me Thuot (AP760846), the 252d MSF Co made three contacts with an estimated VC platoon. Gunships and air strikes supported. Results were two CIDG KIA, 18 WIA (17 CIDG, and one US), and six SA lost. The enemy suffered 25 KIA and one SA, one CSW, two rounds of 60mm mortar, eight HG, three rifle grenades, 25 rucksacks, miscellaneous clothing and miscellaneous documents captured. On 24 Feb, Ben Het CIDG Camp (YB8726) received in excess of 110 rounds of mixed 82mm mortar, 100mm artillery and 122mm rocket. On 25 Feb, Ben Het CIDG Camp received in excess of 44 rounds of mixed 82mm mortar and 100mm artillery with three rounds landing inside the perimeter. Two US were WIA and no significant damage was done. Six km SW of Ben Het (YB839222), the 261 MSF Co engaged an estimated enemy company. Tactical air, artillery and gunships supported. The CIDG suffered two KIA and nine WIA while enemy losses were unknown. On 26 Feb, Ben Het CIDG Camp (YB8726) received 25-30 rounds of mixed 82mm mortar and 72mm recoilless rifle fire. One CIDG was killed and four were wounded. Damage was minor and enemy losses were unknown. On 27 Feb, Duc Co CIDG Camp received 12 rounds of 82mm mortar. Artillery supported. Friendly had nine WIA (One USASF) while enemy casualties were unknown. Ben Het CIDG Camp (YB8726) received 15 rounds of 75mm recoilless rifle fire resulting in negative damage or casualties. Fragments from what had been reported as 100mm artillery have been analysed as 85mm gun.

4. RF/PF Operations: On 26 Feb, 11 km SW of Duc Lap (YU807735), the 282d RF Co received 40 rounds of 82mm mortar fire. Friendly had one KIA and 16 WIA. Enemy casualties were unknown.

5. Other Operations: On 13 Feb, six km North of Pleiku (AR777538), the housing area of the 2d ARVN Ranger Gp was hit by a single 122mm rocket resulting in eight KIA (one ranger and seven children), four women WIA, and 40 houses damaged by blast and fire. One the same day, Loc Thien Subsector, 35 km SE of Ban Me Thuot (AP968730), received a mortar, rocket and ground attack. The attack resulted in five friendly WIA (four US), and one enemy KIA, one PW, three B40 rockets, one B40 rocket launcher, two satchel charges and one AK47 captured.

CONFIDENTIAL

CONFIDENTIAL

AVFA-GC-OT

15 May 1969

SUBJECT: Operational Report of Headquarters, 1 FFORCKV for Quarterly Period Ending 30 April 1969 RCS CSFOR-65 (R1) (U)

On 24 Feb, 13 km SE of Dak To (ZBL25160), Kon Horing Village received a B40 rocket and ground attack. Reaction forces were two RF Co, B Trp, 2d Sqd, 1st Cav, and 2d Co, 3d Bn, 42d ARVN Regt. Civilian results were 52 KIA, 86 WIA (36 were serious and 22 evacuated), five MIA, 2,458 refugees and 138 long houses destroyed. Enemy suffered 12 KIA. Military casualties were seven KIA (one ARVN, six RF/PF), 15 WIA (seven ARVN, eight RF/PF), nine RF/PF MIA. On 27 Feb, Ban Me Thuot City (AQ8333) received 12 rounds of 82mm mortar. Artillery and gunships supported. Friendly had five WIA (ARVN). No damage occurred. During Feb, there were 173 Unidentified Flying Objects (UFO) sightings.

(b) WESTERN HIGHLAND Operation March: The focal point of all enemy initiated activity during March occurred in the Western Highlands primarily in the Ben Het and Polei Kleng areas. Allied forces countered the enemy's threat with the timely deployment of substantial infantry and armored forces and heavy reliance upon artillery and air power. The 4th Inf Div killed 873 enemy in the area and severely crippled the 24th and 66th NVA Regts. Significant enemy equipment captured or destroyed included six 2½ ton trucks, four 105mm guns and two PT-76 tanks.

1. US Operations: On 1 Mar 20 km NW of Polei Kleng (YA835963), A Co, 3d Bn, 12th Inf received SA and mortar fire. Gunships supported the friendly forces. The action resulted in 30 NVA KIA and one PW, five SA, and three CSW captured. US losses were one KIA and 13 WIA. On 29 Mar 28 km NW of Polei Kleng (YB765033), an aircraft from A Trp, 7th Sqdn, 17th Avn Cav observed two NVA trucks parked at a suspected enemy POL point. Tactical air strikes and gunship attacks resulted in six enemy KIA, one truck destroyed, one truck damaged, and one secondary explosion. The damaged truck was later extracted to Polei Kleng. It had Russian markings on the engine, Vietnamese markings on the door and contained 52 rounds of Chi Com 105mm howitzer ammunition. On 3 and 4 Mar 23 km SW of Polei Kleng (YA812879), A Co, 3d Bn, 8th Inf was attacked by an estimated enemy battalion. The company was surrounded. B and D Co and Recon Plat, 3d Bn, 8th Inf attacked to relieve the company. Artillery and Spooky supported the contact. Friendly losses were 22 KIA, and 52 WIA. Enemy losses were 50 KIA. On 4 Mar, 22 km SW of Polei Kleng (YA815869), D Co, 3d Bn, 8th Inf engaged an unknown number of enemy resulting in four NVA KIA and two SA captured with no US casualties. Four km SW of Polei Kleng (ZA009925), elements of 2d Bn (M), 8th Inf engaged an unknown size enemy force in a bunker complex with results of two US WIA and three enemy KIA. Fifteen rounds of 122mm rocket and an unknown number of B40 and mortar rounds were received by installations in the vicinity of Pleiku City which resulted in two ARVN KIA, two ARVN WIA, one US WIA, two ½ ton vehicles damaged and three buildings damaged. On 5 Mar, 24 km SW of Polei Kleng (YA812864), D Co, 3d Bn, 8th Inf received a ground probe of their night location which was supported by enemy SAs and mortars. Action continued throughout the day and sweeps during the next two days produced 112 enemy KIA and 20 SA, two machine guns, one B40 rocket launcher, 30 rounds of B40 rocket, and 25 rounds of 60mm mortar captured. US losses were six KIA and 30 WIA. Nearby (YA828892), B Co and Recon Plat, 3d Bn, 8th Inf received SA and mortar fire from an unknown number of enemy resulting in one US KIA and 11 US WIA. On 6 Mar 25 km SW of Polei Kleng (YA800385), B and C Cos, 3d Bn, 8th Inf encountered an unknown size enemy force in a bunker complex resulting in two enemy KIA and seven US WIA. Two km west of Polei Kleng

CONFIDENTIAL

CONFIDENTIAL

AVFA-GC-OT

15 May 1969

SUBJECT: Operational Report of Headquarters, I FFORCEV for Quarterly Period Ending 30 April 1969 RCS CSFOR-65 (R1) (U)

(ZA008937), A Co, 1st Bn, 69th Arm made contact with an unknown size enemy force which employed SA, MG, mortars, and grenades. The enemy position was overrun with tanks and infantry. One tank and one APC each hit a mine causing light damage. Five US were WIA and seven NVA were KIA as result of the action. Seven US were WIA in three enemy attacks by SAs and mortars on the 1st Bn, 12th Inf Command Post at LZ Mile High, ten km WSW of Poley Kleng (YA9391). Eleven km E of Plei Mrong (ZA225682), D Co, 2d Bn, 35th Inf received sniper fire from an unknown size enemy force which resulted in four US KIA and five US WIA; enemy losses were unknown. On 7 Mar 28 km WNW of Poley Kleng (YB779028), one enemy 105mm howitzer was destroyed by an artillery, gunships, and tactical air attack on an enemy artillery position containing two 105mm howitzers spotted by A Trp, 7th Sqdn, 17th Air Cav. Six US were wounded as the result of a six round 122mm mortar attack on LZ Bass, Command Post of 1st Bn, 69th Armor, at Poley Kleng (ZA0494). Twelve km West of Plei Mrong (ZA2206679), elements of the 2d Bn, 35th Inf found an arms cache containing over 150,400 rounds of SAA, 45 rounds of B40 rocket, 14 rounds of 82mm mortar, 88 rounds of 60mm mortar, 78 hand grenades, five SA, and small amount of additional miscellaneous ammunition. Ten km SSE of Plei Mrong (ZA2268), HQ, A, B, and D Co, 2d Bn, 35th Inf received sporadic sniper fire which lasted throughout the day and six rounds of 82mm mortar. Artillery supported and US forces attacked resulting in 13 enemy KIA. US losses were 11 KIA and 20 WIA. Seven civilians were wounded by four 122mm rockets which were fired into Pleiku City (AR7648). On 8 Mar 11 km west of Poley Kleng (YA936930), the Command Post of the 1st Bn, 12th Inf at LZ Mile High received seven rounds of 122mm rocket and nine rounds of 82mm mortar which wounded seven US personnel. Fifteen km NW of Poley Kleng (YA904994), elements of B Co, 1st Bn, 12th Inf were surrounded by an unknown size enemy force and received 120mm mortars and 122mm rockets. Elements of D Co, 1st Bn, 12th Inf, reinforced and artillery supported. An estimated enemy company in bunkers on a hill was engaged. Results for the action were two US KIA and 15 US WIA while 11 enemy were killed. Elements of the 2d Sqdn, 1st Cav found a total of 3,200 pounds of rice in two locations, 18 km ENE of Camp Enari (AR983392) and 22 km east of Pleiku (AR993483) which was extracted to Le Trung District. On 9 Mar in the vicinity of Poley Kleng (ZA0393), the 1st Bn, 69th Armor at LZ Bass received nine rounds of 122mm rocket and five rounds of 82mm mortar or 75mm recoilless rifle resulting in three US KIA and eight US WIA. Twenty km WNW of Poley Kleng (YA837968), A Co, 3d Bn, 12th Inf while sweeping the area of a SRP contact were attacked by an unknown number of enemy and received sporadic sniper fire which resulted in one US KIA and seven US WIA with enemy losses of three NVA KIA. Fifteen km WNW of Poley Kleng (YA903990), elements of B Co, 1st Bn, 12th Inf received sniper fire. The remainder of B Co, 1st Bn, 12th Inf while reinforcing made contact with an unknown number of enemy in bunkers and the artillery supported the contact. Results were 36 NVA KIA with US losses of six KIA and 11 WIA. Eighteen km west of Poley Kleng (YA837966), the Command Post of 3d Bn, 12th Inf received 15 rounds of 105mm howitzers HE and WP resulting in three US KIA and seven US WIA. Artillery and tactical air were employed on the suspected enemy location and the air cavalry confirmed the enemy 105mm howitzer was destroyed. One US KIA and seven US WIA resulted from a 1st Bn, 12th Inf SRP contact with eight NVA nine km WSW of Poley Kleng (YA949918). Twenty three km WSW of Poley Kleng (YA807882), B and C Co, 3d Bn, 8th Inf found two graves containing a total of nine NVA bodies. On 10 Mar 27 km south of Ben Het (YA836964), the Command Post of the 3d Bn, 12th Inf received 55 rounds of 82mm mortars and eight rounds of 105mm

CONFIDENTIAL

CONFIDENTIAL

AVFA-GC-OT

15 May 1969

SUBJECT: Operational Report of Headquarters, I FFORCEV for Quarterly Period Ending 30 April 1969 RCS CSFOR-65 (RI) (U)

howitzers. Artillery and tactical air attacked the enemy indirect fire position. The US suffered one KIA and 14 WIA. Enemy losses were unknown. Six km west of Polei Kleng (YA995913), A Co, 1st Bn, 14th Inf received sniper fire and an unknown number of unknown type mortar rounds. C Co, 1st Bn, 14th Inf and A Co, 1st Bn, 69th Arm reinforced and artillery supported resulting in 13 NVA KIA and two SA and two CS captured. US losses were six KIA and 28 WIA. Later in the day five km SW of Polei Kleng (ZA9393), A and C Co, 1st Bn, 14th Inf and A Co, 1st Bn, 69th Armor received sporadic mortar and SA fire and attacks. The enemy suffered 30 KIA and two SA and two CS captured. US forces lost two KIA and 29 WIA. Twenty km WNW of Polei Kleng (YB779028), D Co, 1st Bn, 8th Inf captured two enemy 105mm howitzers of US manufacture which were extracted to LZ Bass. On 11 Mar four km SW of Polei Kleng (YA992923), C Co, 1st Bn, 14th Inf found five NVA bodies estimated to be one day old. Twenty five km WSW of Polei Kleng (YA817859), C Co, 3d Bn, 12th Inf made contact with an unknown size enemy force and was supported by artillery and Spooky. The contact resulted in ten US KIA and 27 US WIA while enemy losses were 13 KIA. Six km NNW of Pleiku (ZA233536), a bomb exploded under a conex in Camp Schmidt wounding seven children. On 12 Mar, 21 km WNW of Polei Kleng (YB348002), A Co, 1st Bn, 8th Inf made contact with an estimated enemy squad. C Co and the Recon Plat, 1st Bn, 8th Inf were engaged by an unknown number of dug-in enemy while moving to reinforce. Artillery and tactical air supported the contact which resulted in 23 enemy KIA and US losses of three KIA and 15 WIA. Five km south of Ben Het (YB74403), eight tactical air sorties destroyed one 85mm gun. Twenty two km WSW of Polei Kleng (YA817856), C Trp, 7th Sqdn, 17th Air Cav found five enemy, killed by air, during bomb damage assessment operations. Twenty-three km SW of Polei Kleng (YA815865) 3d Bn, 12th Inf received an unknown number and type of indirect fire for a one hour period resulting in five US WIA. C Co, 3d Bn, 12th Inf again made contact 25 km SW of Polei Kleng, a continuation of the 11 Mar contact and suffered 16 additional US WIA. Ban Me Thuot City Airfield (AQ805045) and the 155th AHC received 20 rounds of 82mm mortar which damaged six UH-1H aircraft (two light, three moderate, one heavy). On 13 Mar, 24 km SW of Polei Kleng (YA815864), D Co, 3d Bn, 12th Inf found seven bunkers, five NVA bodies, one SA, and five CSW during sweep operations. On 15 Mar 20 km NW of Polei Kleng (YA855995), A Trp, 7th Sqdn, 17th Air Cav killed 24 enemy, captured one CSW, and destroyed six bunkers in three contacts without friendly loss. On 16 Mar 15 km NW of Polei Kleng (YA909995), elements of the 1st Bn, 12th Inf found eight NVA bodies. Twenty one km north of Pleiku (AR7766), B Co, 2d Bn, 35th Inf was attacked by an estimated two enemy platoons. Artillery and gunships supported the friendly force which killed seven enemy. Friendly losses were one US KIA and 14 US WIA. On 17 Mar two km West of Plei Mrong (ZA093689), D Trp, 1st Sqdn, 10th Cav reinforce Plei Mrong CSF in a contact with two NVA Platoons resulting in five enemy KIA and one SA and one CSW captured. Friendly losses were three CSF KIA and one CSF WIA. On 18 Mar 23 km SW of Polei Kleng (YA817840), D Co, 3d Bn, 12th Inf was engaged by an unknown size enemy force and was supported by artillery, gunships, and tactical air. Friendly results were four US KIA, 19 US WIA, and three US MIA. Enemy losses were five KIA. On 20 Mar 25 km NW of Polei Kleng (YB802048), A Co, 1st Bn, 8th Inf received sniper fire which resulted in five US WIA. Enemy losses were unknown. Forward Operating Base Number Two at Kontum (AR7888) received B40 rocket, 60mm and 82mm mortar, and possibly 122mm rocket fire followed by a ground/sapper attack with the enemy force estimated to be 200 to 400 personnel.

CONFIDENTIAL

CONFIDENTIAL

AFVA-GC-OT

15 May 1969

SUBJECT: Operational Report of Headquarters, I FFORCEV for Quarterly
Period Ending 30 April 1969 RCS CSFOR-65 (R1) (U)

Extensive damage to the motor pool occurred. Friendly casualties were seven CIDG WIA and three buildings damaged. Enemy losses were 12 KIA. The 584th Engineer compound, nearby, was also attacked and suffered the following losses: Two US KIA, eight US WIA, and destruction of one grader, seven 5 ton trucks, two 2½ ton trucks, two 6 ton vans, two 20 ton cranes, two bulldozers, one paving machine, one water distributor two asphalt distributors, and one air compressor. Four km east of Pleiku (AR794476), Camp Holloway Army Airfield received 25 rounds of 82mm mortar resulting in three CH-47 helicopters damaged (one heavy, two moderate). On 22 Mar three km NW of Plei Mrong (ZA082713), a resupply convoy from B Co, 3d Bn, 8th Inf was attacked by an unknown number of enemy employing AW and mortar fire. A UH-1 aircraft which was supporting the action was shot down. The contact resulted in US losses of ten KIA, 22 WIA, two APCs damaged, and one APC and one UH-1 aircraft destroyed. The enemy suffered four KIA. On 24 Mar 18 km west of Polei Kleng (YA847968), Recon Plat, 3d Bn, 8th Inf was attacked by an unknown number of enemy resulting in three US KIA and nine US WIA. Enemy losses were unknown. On 25 Mar 27 km NE of Pleiku (BR035535), LZ Blackhawk received 20 rounds of 82mm mortar resulting in five friendly WIA and one 2½ ton truck, one 5 ton truck, and one generator damaged. Ten km west of Polei Kleng (YA936930), the Command Post of 1st Bn, 12th Inf at LZ Mile High received three rounds of 82mm mortar resulting in six WIA. Twenty-six km NW of Polei Kleng, B Co, 1st Bn, 8th Inf engaged an unknown number of enemy and artillery and artillery and G/S supported. Friendly results were three KIA, 24 WIA, and two MIA. Enemy losses were one KIA. On 26 Mar 25 km SW of Ben Het (YB823081), the Command Post of 1st Bn, 8th Inf received 19 rounds of 105mm howitzer. Artillery and tactical air were employed on the suspected enemy location. Friendly results were two KIA and three WIA. Enemy losses were unknown. On 27 Mar 34 km SE of Pleiku City (BR047264), C Trp, 2d Sqdn, 1st Cav found a total of 24 tons of rice in several caches. Rice was extracted to Le Trung District. Twenty-five km SW of Polei Kleng (YA825911), a platoon from A Co, 3d Bn, 12th Inf engaged an entrenched enemy force. The rest of the company attempted to link up but a complete link up was not made. Friendly results were six KIA, four WIA, and two MIA. Enemy losses were four KIA. On 28 Mar 33 km SE of Pleiku (BR012257), C Trp, 2d Squadron, 1st Cav found 15 tons of rice in an underground hut. The rice was extracted to Le Trong District. Five km north of Pleiku (AR239531), the 124th Transportation Co received two rounds of 122mm rocket which resulted in six WIA and moderate damage to one 5 ton tractor, one 2½ ton truck, and one 500 gallon tank. Twenty-eight km SW of Ben Het (YB805035), B and C Co, 1st Bn, 8th Inf received 83 rounds of 105mm howitzer during the day resulting in one KIA and four WIA. Counterartillery fire was employed on the suspected enemy location with unknown results. Twenty-five km SW of Polei Kleng (YA833614), A Co, 3d Bn, 12th Inf established contact with two enemy platoons in bunkers. Air strikes in support of the contact caused 20 secondary explosions and an unknown number of enemy casualties. There were no friendly casualties. Twenty-two km SW of Polei Kleng (YA822852), B and D Co 3d Bn, 12th Inf received 51 rounds of 82mm mortar and a sapper attack. Gunships supported the US force. Friendly losses were two KIA and 25 WIA. Enemy losses were 22 KIA. On 29 Mar 12 km NE of Plei Mrong (AR778714), Recon Plat, 2d Bn, 35th inf observed and engaged 15 NVA. Artillery supported. Friendly results were three WIA. Enemy losses were ten KIA and two SA and a field telephone captured. Twenty-eight km SE of Pleiku (BR028274), elements of 2d Sqdn, 1st Cav found five tons of rice which was extracted to Le Trong District.

CONFIDENTIAL

CONFIDENTIAL

AVFA-GC-OT

15 May 1969

SUBJECT: Operational Report of Headquarters, I FFOFCEV for Quarterly Period Ending 30 April 1969 RGS CSFOR-65 (B1) (U)

Twenty-four km east of Camp Enari (BR045350), elements of D Trp, 7th Sqdn, 17th Air Cav found over three tons of rice in an underground hut with punji stakes at the entrance. Eighteen km west of Polei Kleng (YA887937), 80 new bunkers with overhead cover were observed. Artillery was employed, and ten enemy were killed. On 30 Mar 24 km east of Camp Enari (BR048368), elements of D Trp, 7th Sqdn, 17th Air Cav discovered a 12 ton rice cache. Thirteen km SE of Camp Enari (AR994237), elements of the 2d Bn, 1st Cav discovered 15 tons of rice. Twenty-five km SW of Polei Kleng (YA826811), A Co, 3d Bn, 12th Inf became engaged with an unknown number of enemy who employed SA, AW, recoilless rifle, and mortar fire. Two platoons from C Co, 3d Bn, 12th Inf reinforced. Mortar fire continued after ground contact broke. Friendly results were six KIA and 37 WIA. Enemy losses were 25 KIA. Forty-five km west of Polei Kleng (YA593845), an LOH from the 4th AVN Bn received ground fire and engaged an unknown number of enemy resulting in six enemy KIA.

2. ARVN Operations: On 7 Mar, 13 km SE of Dak To (ZB158158), the 2d Bn, 42d ARVN Inf received 20 rounds of 82mm mortar resulting in one KIA and 12 WIA. On 8 Mar five km east of Dak To (ZB0622), the 42d ARVN Inf Headquarters at Tan Canh received 50-70 rounds of 82mm mortar and a ground probe resulting in seven ARVN KIA and 21 ARVN WIA while three enemy were killed and three SA and one crew served weapon were captured. On 15 Mar, 18 km SE of Dak To (ZB185192), elements of the 1st Bn, 42d ARVN Inf engaged an enemy squad killing seven enemy and capturing one B40 rocket launchers without friendly loss. On 16 Mar 13 km SW of Ban Me Thuot (ZU246886), elements of the 2d Bn, 45th ARVN Inf engaged an unknown size enemy force and gunships supported. Friendly results were one KIA and six WIA. Enemy losses were eight KIA and eight SA and one CS captured. On 17 Mar six km east of Dak To (ZB054217), the MACV Compound and the 42d ARVN Regt Headquarters at Tan Canh received 90 rounds of 82mm mortar resulting in eight WIA (two US, six ARVN) and three buildings and six vehicles damaged. Artillery and Spooky fired on the enemy mortar position with unknown results. On 20 Mar at Ban Me Thuot (AQ8140), 25 rounds of 82mm mortar were received. Nineteen rounds struck the 185th and 155th AHC and six rounds were scattered over the RF/PF, 23d ARVN Div Training Center, and 853d ARVN Ord Co. Casualties were two ARVN KIA and six ARVN WIA. No damage to aircraft occurred. Seven km east of Dak To (ZB0622), the 47th ARVN Regt at Tan Canh received a mortar attack and ground probe which resulted in friendly casualties of nine KIA and nine WIA. The enemy suffered 12 KIA and five PW. On 25 Mar 12 km south of Ban Me Thuot (AP826865), elements of the 4th Bn, 45th ARVN Inf established contact with an estimated enemy platoon and artillery supported. Friendly losses were none. Enemy losses were six KIA and one SA captured.

3. CIDG Operations: On 1 Mar, four km west of Ben Het (YB829269), a 70 man patrol from the camp received sporadic SA and AW fire resulting in six CIDG and one US WIA. Enemy casualties were unknown. Spooky, artillery, and gunships supported the CIDG. On 2 Mar, Ben Het CIDG Camp (YB872259), received 88 rounds of mixed 75mm recoilless rifle, 82mm mortar, and 85mm gun resulting in seven US WIA. On 3 Mar near Ben Het CIDG Camp (YB872259), CSF elements observed an estimated 100 NVA. The enemy engaged the CSF with AW and B40 rockets. The 262d MSF Co reinforced and elements of the 7th Sqd, 17th Air Cav and tactical air supported. A FAC reported 30 enemy killed by air and also one caliber .50 MG destroyed.

CONFIDENTIAL

CONFIDENTIAL

AVFA-40-01

15 May 1969

SUBJECT: Operational Report of Headquarters, I FFORCEV for Quarterly
Period ending 30 April 1969 RCS CSFok-65 (R1) (U)

CIDG losses were one CSF KIA and eight CSF WIA. Fifteen enemy bodies were found at a later date. The CIDG Camp Later received 85 rounds of 82mm mortar and 100 rounds of mixed HE and WP 85mm gun. CSF elements and a platoon of the 1st Bn, 69th Arm Later became engaged with an estimated enemy battalion supported by ten enemy tanks. Two enemy PT-76 tanks and one US tank were destroyed and two US were KIA. Spooky, tactical air, and artillery supported the action throughout the day and night. On 8 Mar, in the vicinity of Dak Pek (YB951661), Dak Pek CSF elements made contact with an estimated two enemy companies. Gunships and 4.2 inch mortars supported the contact which resulted in four CSF KIA and three CSF WIA. Enemy losses were unknown. Four km SSW of Ben Het (YB859224), Ben Het CSF element walked into the perimeter of an estimated 60 NVA. Tactical air and artillery supported the CSF. Results were two CSF KIA and ten CSF WIA; enemy losses were unknown. On 9 Mar five km SE of Plei Me (ZA219065), a CSF Co from Plei Me CIDG Camp made contact with an unknown number of enemy. The contact was supported by Spooky and artillery and resulted in 15 enemy KIA without CSF casualties. On 10 Mar, four km NW of Plei Mrong (ZA083696), CSF elements engaged an unknown number of enemy resulting in six enemy KIA and three SA captured. CSF losses were one KIA and one WIA. On 16 Mar five km SW of Ben Het (YB839222), elements of the 2d MSF Bn were attacked by an estimated enemy company. Air strikes, gunships, and artillery supported the MSF in the contact which resulted in 27 NVA KIA and friendly casualties of two US KIA and 13 WIA (one US and 12 MSF). On 30 Mar, 16 km SE of Duc Lap (ZU034657), CSF elements from the camp established contact with an estimated NVA platoon resulting in five CIDG WIA and 35 NVA KIA and one SA captured.

4. RF/PF Operations: On 5 Mar, 17 km SE of Dak To (ZB148150), Kon Honong Village was attacked by an estimated enemy company. The 64th, 65th, and 66th PF Platoon, defending the village, were driven out. Two RF Co reinforced at first light and were stopped north of the village by heavy SA, B40, and mortar fire. Friendly forces set up positions north, NW, and south of the village. In the afternoon, 5th Bn, 42d ARVN Inf and two RF Co swept through the village. Results of the contact were seven friendly KIA (one RF, one PF, one PSDF, four civilians), 26 WIA (13 US, four RF, two PF, and seven civilians), two APCs and two tanks damaged, and six houses destroyed; enemy losses were four KIA and one SA captured. On 9 Mar, ten km west of Kontum (AZ118915), the 103d RF Co received SA fire and five rounds of B40 rocket while in an ambush position. Artillery, Spooky, and mortars supported the contacts which resulted in two RF KIA and six RF WIA while enemy losses were unknown. On 14 Mar, 24 km SE of Pleiku (AR908268), elements of the 204th RF Co received SA fire while enroute to outposts east of Camp Enari while traveling on a secondary road resulting in three RF KIA and four WIA (two US, two RF). Gunships and artillery fired into the area of contact and enemy losses were unknown. On 24 Mar, nine km west of Kontum City (ZA175916), an estimated two VC platoons attacked Ha Long Hamlet which was defended by the 108th PF Platoon. The VC killed the Hamlet Chief and destroyed his house. Recon Platoon, 2d Bn, 8th Inf (M) and the 102d and 103d RF Co reacted and received SA and B40 rocket fire. Friendly losses were six KIA (three US, two PF, one civilian), two US WIA and one APC damaged. Enemy losses were six VC KIA. On 25 Mar, seven km NE of Plei Mrong (ZA179721), a truck with RF personnel hit a mine resulting in 12 WIA. Nearby, a second truck hit a mine in four KIA and two WIA. Later, a third truck hit a mine resulting in five WIA.

CONFIDENTIAL

CONFIDENTIAL

AVFA-GC-OT

15 May 1969

SUBJECT: Operational Report of Headquarters, I FFORCEV for Quarterly
Period Ending 30 April 1969 RCS CSFOR-65 (R1) (U)

5. Other: On 5 Mar, the Ban Me Thuot radio tower received seven rounds of 60mm mortar resulting in five WIA. Eighteen km north of Kontum on Highway QL-14 (ZB152112), a Vietnamese bus hit a mine resulting in six civilians killed, six civilians wounded, and destruction of the bus. On 7 Mar 16 km SE of Dak To (ZB148150), an estimated enemy company entered Kon Honong Village. 104th RF Co, 439th RF Co, three companies from the 2d Bn, 42d ARVN Inf, and B Trp, 2d Sqd, 1st Cav reacted. Artillery, gunships, and tactical air supported. Friendly losses were four KIA (two RF and two ARVN), six WIA (three US, one RF, and two ARVN), three homes burned, and one APC damaged. Enemy losses were 20 NVA KIA and five SA, one M79 grenade launcher, one B40 rocket launcher, and a small amount of ammunition captured. On 9 Mar, two km south of Da Pek (YB951664), a company size element of Dak Pek CSF on election security made contact with an estimated NVA company in a built-up position who employed SA, AW, mortars and claymores. Artillery, 4.2 inch mortars and tactical air supported CSF forces. Results of the contact were one CSF KIA, two CSF WIA, and two CSF MIA. The NVA had one KIA. On 9 Mar, two km north of Kontum City (AR7888), a German nurse held captive by the enemy was released. While in captivity, she was indoctrinated and signed documents. She was also made to appear on Radio and TV Hanoi. While a prisoner, she worked as a farm laborer. On 11 Mar, five km south of Dak To (ZB067215), a National Police check point received an unknown number of M79 rounds from an unknown size enemy force resulting in five friendly WIA. RF and PF elements from Tan Canh reinforced. Enemy casualties were unknown. On 12 Mar, six km west of Pleiku (ZA168474), Plei Blang Village was attacked by an estimated enemy company employing SA, AW and mortars. The village was defended by one platoon of 145th RF Co, RD Team, and PSDF. The attack resulted in friendly casualties of five KIA. Thirty four km SE of Ban Me Thuot (AP985749), Buon Dieu Hamlet was attacked by an estimated VC Company using SA and mortars resulting in friendly losses of nine KIA (one RD, three PF, five civilians), 11 WIA (three PF, eight RD), two civilians MIA and 21 SA and two radios lost. Enemy losses were unknown. On 13 Mar, five km north of Kontum, the villages of Kon So Tiu (AR778935) and Kon Ro Long (AR781940) were attacked by an estimated enemy battalion. Two RF platoons defended but were forced to withdraw. The 3d Bn, 42d ARVN Inf and the 403d, 404th and 406th Scout Co reacted and set up blocking positions. ARVN Artillery and Spooky supported. Friendly losses were 14 KIA (two PF, one National Police, 11 Civilians), 31 WIA (one PF, 30 civilians), seven MIA, (five PF, two civilians including the Village Chief), three SA and one radio lost, 18 houses and one school destroyed, three houses and a church damaged by fire, and 160 people homeless. Enemy losses were two NVA KIA and three SA, a small amount of miscellaneous ammunition, and documents which identified the unit as the 304th Sapper Bn captured. Villagers reported that an additional ten enemy bodies were carried away. On 16 Mar, 19 km NE of Duc Co (ZAO28299), an unknown number of enemy entered Plei Rangol Hamlet and killed one civilian and abducted three others. On 20 Mar 12 km SW of Pleiku (ZA218352), the resettlement village of Plei Ring De was attacked by an estimated enemy platoon using B40 rockets, SA, and 60mm mortars. A short while later, ten 122mm rockets were received. Friendly losses were one KIA (RF) and 12 WIA (nine RF, one US, and two civilians). Enemy losses were three NVA KIA. Thirty km NNW of Kontum (ZB126156), Kon Horing Village received B40 rockets, SA, and 150-200 rounds of mixed 60mm and 82mm mortar and possible 122mm rocket. Six vehicles from A Btry, 1st Bn, 92d Arty were damaged and friendly casualties were 13 KIA (one US, five ARVN, seven civilians), and 52 WIA (four US, 12 ARVN, and 36 civilians).

CONFIDENTIAL

CONFIDENTIAL

AVFA-CC-OT

15 May 1969

SUBJECT: Operational Report of Headquarters, 1 FFORCEV for Quarterly Period Ending 30 April 1969 RCS CSFOR-65 (R1) (U)

Enemy losses were two KIA and two SA and one CSW captured. On 21 Mar, 30 km SE of Ban Me Thuot in the vicinity of Lac Thien (AP927736), an estimated enemy company entered Buon Juin Hamlet. The enemy forced RF and PSDF defenders to one corner of the village and then conducted a propaganda lecture and burned the MAT Team house. Friendly casualties were five KIA (one RF, one PSDF, three civilian), seven WIA (three PF, four civilian), one PF MIA, and three SA lost. Enemy casualties were unknown. Eight km NW of Kontum (ZA181911), Mang La Hamlet was attacked by an unknown number of enemy. The 23d PF Plat defended. Friendly losses were three KIA (two civilians, one PF) and five PF WIA. Enemy losses were unknown. On 24 Mar, ten km NW of Ban Me Thuot (AQ761102), Truong Song Team Number Two defending Dha Kmur Hamlet was attacked by an estimated two enemy companies resulting in negative friendly casualties and five enemy KIA. On 29 Mar, ten km west of Gia Nghia (YU8525), Bu Sre Village was attacked by a VC platoon. The village was undefended except for RD Cadre. Two RD squads near the village attempted to react but were engaged. Friendly losses were five KIA (four RF, one civilian), six WIA (four RD, two civilians) four RD MIA, one 2½ ton truck destroyed, one RD building damaged, and 19 SA lost. Enemy losses were unknown. On 30 Mar, five km NE of Kontum City (AR820918), an estimated two enemy platoon entered Kon Joreh Hamlet. Elements of the 11th PF Plat defended. The enemy burned the Hamlet Chief house. Friendly losses were five KIA (four civilians, one PF) and two SA lost. Enemy losses were unknown. During Mar, there were 190 UFO sightings.

(c) Western Highlands Operations-April. The enemy's avoidance of general engagement since his major defeats in March allowed resumption of emphasis on pacification support and RVNAF support. The level of enemy initiated activity dropped sharply, consisting predominantly of mining and village intrusion. When enemy units were discovered, it proved very costly to him.

1. US Operations: On 2 Apr 26 km SW Plei Kleng, (YA816796) Cos A and C, 1st Bn, 22d Inf encountered a dug in enemy force using SA, AW, booby traps, and claymores. Artillery and air strikes supported. Friendly losses were one KIA, 18 WIA. Enemy losses were two KIA, one SA captured. On 5 April, 25 km SW Plei Kleng vicinity YA808822, elements of Cos C and D, 1st Bn, 22d Inf were engaged by an enemy force which used SA, 60mm mortar, and B-40 fire. US elements supported by artillery and Tactical Air swept area, met resistance and broke contact to return to night location. Friendly losses were six KIA, 18 WIA, and two MIA. Enemy losses were 23 KIA. On 6 Apr, four km east of Pleiku at AR305460, Camp Holloway Airfield received 16 rounds of 82mm mortar which landed near the control tower damaging 19 helicopters. Artillery and gunships supported. Ban Me Thuot City Airfield at AQ805043 also received 16 rounds of 82mm mortar, damaging 10 helicopters. Element of 45th ARVN Regiment swept area as artillery and gun ships supported with negative results. On 10 Apr Trp D, 7th Sqdn, 17th Air Cav found three caches of rice, totaling 46 tons. The largest cache was in a hut complex 15 km NW of Camp Enari at AR926283. On 15 Apr, 10 km E of Plei Djereng at YA980460 Trp A, 1st Sqdn, 10th Cav found 2½ tons of rice which was taken to LZ Oasis. At 150750H, 13 km SSE of Pleiku, the 4th Inf Div base at Camp Enari (AR8035) received 25 rounds unknown type mortar fire, wounding 14 US and one civilian. Artillery and gunships engaged two suspected enemy locations with no evident results. On 24 Apr, 18 km NW of Plei Kleng at YB888018, 3rd Plat, Co B, 1st Bn, 12th Inf was engaged by an unknown number of enemy. Co C, 1st Bn, 12th Inf and two platoons from Co B, 1st Bn, 12th Inf reinforced, and Tactical Air and artillery supported. Losses were five US KIA and 11 US WIA.

CONFIDENTIAL

CONFIDENTIAL

AVFA 40-01

15 May 1969

SUBJECT: Operational Report of Headquarters, I FFORCEV for Quarterly
Period Ending 30 April 1969 R03 CSFOR-65 (R1) (U)

The enemy lost 10 KIA and one SA. On 24 Apr at ZV1304470 19 km SE of Tieu Atar, elements of 7th Sqdn 17th Air Cav found five tons of rice which was evacuated. On 25 Apr, 20 km SSW of Bu Prang at YU435 and YU4039, the 1st MSF Bn was heavily engaged by an estimated NVA Regt employing 12.7mm MG, mortars, and rockets. Trp A, 7th Sqdn, 17th Air Cav and air strikes supported after weather permitted. 5th MSF Bn reinforced; and 1st Bn, 35th Inf was positioned as reserve. One Destoff aircraft was shot down during the action. Friendly losses were one KIA, 26 WIA and one UH1D destroyed. The enemy lost 52 KIA. On 27 Apr, 16 km NW Polei Kleng at ZB885013 2d Plt, Co B, 1st Bn, 12th Inf found 27 rounds 75mm Rk, 107 rounds 60/82mm mortar, and 1100 rounds SA ammo, which they destroyed. On 28 Apr, 18 km SW of Pleiku at ZA097343 Co C, 1st Bn, 35th Inf found a 50M X 200M mine field of 30-40 bouncing AP mines. Minefield was destroyed in place. On 29 Apr, 18 km NW of Polei Kleng at YB886315 Co C, 1st Bn, 12th Inf found an ammo cache of 93 60mm rds, 84 RPG rds, one SKS, one MG, seven rounds 75mm Rk, eight rounds 82mm, eight protective masks, 7400 rounds SA ammo, 98 assorted grenades, and miscellaneous equipment, which was evacuated to 2d Bde, 4th Inf Div CP.

2. CIDG Operations: On 7 Apr, 23 km NNE of An Lac at BP018662, CSF element received SA fire from an unknown number of enemy. CSF engaged, supported by air strikes. Friendly losses were one KIA and five WIA; enemy losses were 20 KIA, six captured. On 10 Apr, 21 km SSE of Duc Lap at LU107683, a "Shadow" aircraft firing H&I caused secondary explosions and received ground fire. Artillery and Tactical Air engaged enemy. Action occurred at 102230H. BDA at 111100h located an enemy base with new graves and seven bodies killed by mini-guns. In the vicinity at ZU079692, a Duc Lap CSF engaged two NVA platoons armed with AK47's. The enemy broke contact immediately. An air strike was delivered at ZU069659. A patrol then found 11 enemy bodies, killed by napalm and 20mm fire, in one mass grave. On 19 Apr, 15 km SSW of Bu Prang at YU409409, a CIDG Co was engaged by an estimated NVA Battalion. Gunships and Tactical Air supported. Friendly losses were three KIA and nine WIA (one US, eight CIDG). The enemy lost 27 KIA and four SA. On 22 Apr, 23 km SE of Tieu Atar via ZV225525, a 23d ARVN Div Snoop mission engaged 25-30 enemy. The Tieu Atar CSF Co reacted, pursuing the enemy north. 7th Sqdn, 17th Air Cav, and Tactical Air, and "Shadow" supported, achieving 59 secondary explosions. Friendly losses were three WIA. Enemy losses were 96 KIA, and 14 SA captured. On 30 Apr, 23 km SW of Bu Prang at YU383385 the 1st MSF Bn found a cache with 30 rds of 75mm Rk, 41 rounds 60mm mortar, one bag of charges and fuzes, and 300 pounds rice. At YU391369, 5th MSF Bn found a battalion size base area with an extensive medical complex including US and Chinese surgical instruments, detailed medical charts, documents, and three SA. At YU390364 another base camp was found with a 1.5 HP Japanese generator, 100 lbs lined paper, 50 reams typewriter paper, three tons rice, 50 lbs tobacco, and 100 vials medicine.

3. RF/PF Operations: On 18 Apr 14 km NW of Kontum City at ZB183009, the 1st and 2nd RF Plats located in Dak Dien Hamlet were attacked by a VC Platoon from the south and a VC Company from the north. Two to four rounds of 82mm mortar were fired into the hamlet. A reaction force was provided by 105th RF Co, 743th RF Co, and elements of 2nd Bn, 8th Inf (M). Friendly losses were 10 KIA (six civilians, three RF, one RSDF), two WIA (one civilian, one RSDF), three PF MIA, four SA lost, one radio destroyed, two houses destroyed, one house damaged, and seven cows killed. On 24 Apr 35 km NE of Ban Me Thuot at B143216, the 25th RF Co found and destroyed four tons of rice. On 28 Apr 30 km NE of Ban Me Thuot at B1523, 25th RF Co found 7 tons of rice which they destroyed. The same unit later found two elephants believed to be used by VC.

CONFIDENTIAL

CONFIDENTIAL

AVFA-GC-OT

15 May 1969

SUBJECT: Operational Report of Headquarters, I PFORCEV for Quarterly
Period Ending 30 April 1969 RCS CSFOR-65 (R1) (U)

4. Other: During Mar, there were 46 UFO sightings. During the entire reporting period, concerted efforts were made to identify UFOs. Further discussion of these efforts is precluded by the classification of this report.

(d) BINH DINH Operations February: Activity in Binh Dinh Province continued to lead all other provinces in number of incidents. However, the majority of reported actions were small unit contacts with generally minor results. Enemy activity was directed predominantly against Territorial Forces and civilian population centers.

1. US Operations: The 173d Abn Bde continued combined operations with units of the 22d ARVN Div primarily in the Dam Trao Plain and Phu My Valley areas. TF 1-503 Abn Inf began Operation DAREY CREST/DAN CUONG 40-02 with 3rd Bn, 40th ARVN Regt, on 1 Feb, (vic BR9082) South of Bong Song. The operation continued through the month. Friendly results as of 28 Feb were one KIA and five WIA. Enemy losses are 43 KIA, one PW, 256 det, 14 SA, 1 CSW and 60,000 piasters CIA. TF 2-503 Abn Inf initiated Operation Darby Trail II/DAN CUONG 40-1 with 2nd Bn, 40th ARVN Regt (vic BS8608) north of Bong Song. Friendly results through 28 Feb were three KIA and 16 WIA. Enemy losses were 47 KIA, one PW, 73 DET, 14 SA and one ton of rice CIA. The only major contact of this operation occurred 14 Feb West of LZ English when a Hawk Team engaged an unknown number of enemy (BS919097) resulting in 24 enemy KIA, three PW's, nine det and six SA CIA against two US WIA. On 23 Feb, the 184th Ord Bn ammunition dump at Qui Nhon was attacked by an unknown number of enemy employing mortars and B40 rockets. Friendly losses were one KIA, four WIA and 4,411 short tons of ammunition destroyed. This loss resulted in critical shortages of 81mm mortar ammunition (zero balance) and 105 mm How Hs (85,000 rounds).

2. ROK Operations: During the period 10-16 Feb, the 1st ROK Regt (10 cos) conducted Operation BKE HO 19 against local force VC NE of Phu Cat (vic BR9453). The results of this operation were 21 enemy KIA, seven PW's, 13 SA and 1 CSW captured.

3. RF/PF Operations: On 23 Feb, SE of Phu My, the 971 RF Co was attacked by an estimated VC company (BR9765) resulting in eight KIA and six WIA with three SA lost. Enemy losses are unknown. On the same day, the 77 PF Plat and RD Team #8 (BR8837) were overrun by an estimated enemy battalion NW of Qui Nhon. Friendly losses were 21 KIA, two WIA, nine SA and two CSW lost. Enemy losses were unknown.

4. Other Operations: On 6 Feb, near Phu Cat (BR907478), an unknown number of enemy detonated an explosive device in a market resulting in 11 KIA (three RF, eight civ) and 33 WIA (three RF, 30 civ). On 12 Feb, a terrorist threw a hand grenade into a house SE of Phu My (BR983488) resulting in three KIA (civ) and nine WIA, (one RF, two PF, six civ). A total of ten terrorist attacks or attacks by hand grenades and shooting at civilians were reported during the month with the following results: Civ - 23 KIA and 42 WIA; RF - four KIA and three WIA; PF - two WIA; PSDF three KIA and five WIA.

CONFIDENTIAL

CONFIDENTIAL

AVFA-GC-01

15 May 1969

SUBJECT: Operational Report of Headquarters, I FFORCEV for quarterly period ending 30 April 1969 (CSPOR-6) (R1) (U)

(e) Binh Dinh Province Operations March: Operations during the month witnessed several significant contacts by the 173d Abn Bde. Emphasis remains on offensive small unit operations (Hawk (counter-killer)). Hawk Teams killed nearly 200 enemy during the month. As the month closed, Operation SLY SCOP had impressive results. A brigade OP has been established on a mountain top SE of Bong Son and equipped with terrestrial binoculars. Personnel manning the OP observed enemy activity to the east six km away. Quick reaction resulted in 50 enemy killed and 41 enemy sampans sunk.

1. US Operations: On 1 Mar, three km SE of LZ English (BR905977), Hawk Team 25E from the 173d Abn Bde discovered 1500 pounds of rice which was extracted to Tam Quan District Headquarters. On 3 Mar, four km SW of LZ English (BR612007), elements of D Trp, 2d Sqdn, 1st Cav and A Co, 2d Bn (Abn), 503d Inf discovered a cache containing one and a half tons of rice. Fourteen km east of An Khe (BR615465), a 54th Trans Bn convoy was attacked on Highway QL-19 wounding four US, destroying one gun truck, and damaging three other trucks. On 10 Mar at Qui Nhon (CRO824), the 184th Ord Bn was hit by sappers, a fire started on a pad causing 105mm illumination to explode. A total of three pads were destroyed and three pads damaged. Friendly losses were nine WIA. On 13 Mar, 20 km west of An Khe (BR274475), Hawk Team 52B (4th Bn, 503d Abn Inf, 173d Abn Bde), engaged unknown number of enemy resulting in four enemy KIA and four SA captured. On 14 Mar, 30 km SW of An Khe (BR204425), C Co, 4th Bn, 503d Abn Inf found two caches containing a total of 30 B-40 rockets, 30 B-41 boosters, 27 82mm fuzes and 7,500 rounds of SA ammunition. On 15 Mar, six km SE of Bong Son (BR900913), Hawk Team 14B and C Co, 1st Bn, 503d Abn Inf engaged an unknown number of enemy resulting in three enemy killed, four PW's and three SA captured. On 16 Mar, 16 km NE of Pnu My (CRO54740), element of D Co, 2d Bn, 503d Abn Inf conducted a combat assault into an enemy location. Friendly losses were one KIA, five WIA, one LOH destroyed. Enemy losses were 19 KIA, four SA captured. On 17 Mar, 20 km SW of An Khe (BR254514), A Co, 4th Bn, 503d Abn Inf and D Trp, 2d Sqdn, 1st Cav engaged an unknown size enemy force. Friendly losses were negative. Enemy losses were six KIA, two PW, five SA captured and 26 detained. On 20 Mar, LZ English (BS8801) received 12 rounds of 82mm mortar resulting in six US WIA and eight UH-1 helicopter lightly damaged. On 20 Mar at Qui Nhon, Tank Farm Number 2 was hit by enemy sappers. Five tanks were destroyed including 131,900 gallons of JP-4, 163,000 gallons of MOGAS and 264,300 gallons of diesel. On 20 Mar, one km north of An Khe (BR4844) Camp Radcliff received 62 mortar rounds and a sapper attack resulting in two friendly KIA and six WIA. Enemy losses are unknown. On 23 Mar, nine to 16 km west of Qui Nhon, the Qui Nhon ASP (BR955319), the 5th Main Bn (CRO04203), and the 184th Base Depot (CRO25162) received separate ground attacks by unknown size enemy forces. Fire was set to four pads in the ASP. Results of the attack were one US KIA, 31 US WIA, and 7,452 M16 mines, 2,960 rounds of 4.2 inch illumination, 23,767 rounds of 105mm HE, 60 rounds of 105mm leaflet, and 9,971 rounds of 155mm HE destroyed. Enemy losses were unknown. Ten km NW of Qui Nhon on Highway QL-1 (CRO02275), a 54th Trans Bn convoy of six vehicles and an ARVN convoy of an unknown number of vehicles were attacked by an estimated 50 enemy from four sides who also used a roadblock. Gunships and spookys supported and a reaction force from the 2d ARVN Div reinforced. Friendly losses were three KIA (two US, one ARVN) and 12 WIA (two US, ten ARVN). Enemy losses were unknown. Equipment losses were one US 1/4 ton truck destroyed and eight 2 1/2 ton trucks destroyed.

CONFIDENTIAL

CONFIDENTIAL

AVFA-GC-01

15 May 1969

SUBJECT: Operational Report of Headquarters, I FFORCEV for Quarterly Period ending 30 April 1969 RCG CSFOR-65 (R1) (U)

On 27 Mar, 1st km SE of Bong Son (BR90896), Hawk Team 22E (2d Bn, 505d Abn Inf) conducted a combat assault into an area where JKY-SCOPE observed numerous sampans. Swift boats were called in and sank 41 sampans while the VC dumped cargo overboard. Friendly results were one KIA. Enemy losses were 50 KIA, five SA, 105 detainees, one Hoi Chanh, 11 SA, and ten pounds of documents. On 24 Mar 16 km west of An Khe (BR506450), Hawk Team 54C (1st Bn, 50th Mech Inf) made contact with an unknown size enemy force. A reaction force from Pump Station number 7 received heavy SA fire. Pump Station number 7 then received a probe and the reaction force retained. Friendly losses were 13 KIA. Enemy losses were unknown.

2. ARVN Operations: On 4 Mar, 11 km north of Bong Son (BS905084), elements of the 2d Bn, 40th ARVN Inf detonated a 105mm and 155mm booby trap which resulted in two ARVN KIA and six ARVN WIA. On 9 Mar, seven km NE of Bong Son (BS958004), an APC from 2d Sqdn, 14th ARVN Arm Cav detonated an AT mine wounding five. On 11 Mar, ten km NE of Bong Son (BS922089), the 2d Bn, 40th ARVN Inf was attacked by an unknown number of enemy. Friendly losses were one KIA and seven WIA. Enemy losses were five KIA, nine SA, and five SA captured.

2. CIDG Operations: On 1 Mar in the vicinity of Vinh Thanh (BR619604), a CSF convoy was attacked by an estimated VC company and the CSF Command Post received ten rounds of 82mm mortar. Gunships supported the CSF elements. The CIDG suffered one KIA and seven WIA while enemy losses were unknown. On 2 Mar, 17 km SW of LZ English (BR794853), a Hawkeye aircraft sighted four VC with weapons. Artillery fire into the area of the sighting producing three secondary explosions. Ha Tay Co elements swept the area and discovered seven enemy bodies and four SA. On 24 Mar, four km NW of Vinh Thanh CIDG Camp, a CSF Co ambushed a VC platoon. The VC withdrew and the CSF pursued. Friendly results were one KIA and one WIA. Enemy losses were six KIA and three SA captured.

4. RF/PF Operations: On 1 Mar, seven km NW of Phu Cat (BR860544), an estimated enemy squad entered My Hoa Hamlet and burned 12 houses. The 40th PF Platoon reacted and the enemy withdrew. Friendly had negative casualties and enemy losses were unknown. On 10 Mar, 12 km north of Phu Cat (BR887583), two VC dressed as ROKs entered Van Phouc hamlet. The 206th PF Platoon recognized them and engaged. The VC fled, throwing hand grenades. Two civilians were KIA and 11 WIA. Enemy casualties were unknown. On 12 Mar, nine km NW of Qui Nhon (CRO74267), the 939 and 476 RF Co on a reconnaissance operation engaged three VC in spider holes. Nine more enemy were found in graves. Twelve enemy were KIA. On 14 Mar, 13 km SW of Phu Cat (BR878362), the 84th PF Platoon and RD Team 9 were attacked by an estimated two enemy companies. Friendly results were six WIA (three civilians, three PF), one PRC-10 radio lost. Enemy losses unknown. On 17 Mar, 15 km south of Phu Cat (BR899337), the 79th PF Platoon and 185th RF Co repelled an attack by two enemy companies. Friendly losses were one KIA (RF), eight WIA (three RF, five PF). Enemy losses were 10 KIA. On 18 Mar, nine km north of Ha Tay (BRO20926), the 232d RF Platoon received 20 rounds of 82mm mortar wounding one PF. On 21 Mar, 21 km NW of Qui Nhon (BR904339), the 185th RF Co ambushed an enemy company. Friendly losses were one KIA, and two WIA. Enemy losses were 16 KIA, four SA captured. On 21 Mar, seven km NE of Ha Tay (BR897387), the 457th RF Co and RD Team 5b received mortar, small arms and automatic weapon fire resulting in eight KIA (RF), eight WIA (seven RF, one SA), and one RF MIA. Eight SA and

CONFIDENTIAL

CONFIDENTIAL

AVFA-OC-07 15 May 1969
SUBJECT: Operational Report of Headquarters, I FFORCEV for Quarterly
Period Ending 30 April 1969 RCS CSPOR-65 (R1) (U)

two ratios lost. Enemy casualties are unknown. On 21 Mar, one km west of Binh Khe (BR706596), the 175d RF Co was attacked by an estimated enemy company resulting in four KIA (three RF, one civ), 11 RF WIA. Enemy losses were unknown. On 21 Mar, 12 km north of Bong Son (BR37094), elements of the 104th RF Co was attacked by an estimated enemy squad. Friendly losses were one KIA and four WIA. Enemy losses were one KIA. On 21 Mar, six km SW of Phu My (BR902675), a PSDF element was attacked by an unknown number of enemy. Friendly losses were two KIA (PSDF), six WIA (one PSDF, five civ) and one PSDF MIA. One enemy was captured. On 22 Mar, six km north of Bong Son (BR30009), the 15 PF Plat was attacked by an estimated two VC platoons. During the contact, the enemy entered An Duong Hamlet and burned approximately 100 homes. One company of 4th Bn, 40 ARVN Inf contacted and the 175d Abn Bde provided a fire fighting team. Friendly results of the action were three KIA (two PF, one civ), three PF WIA, approximately 100 houses destroyed, and approximately 1500 people homeless. Enemy losses were unknown. On 24 Mar, nine km north of LZ English (B3912085), elements of the 73d RF Co detonated a booby trap resulting in two KIA and three WIA. On 26 Mar, five km south of Bong Son (BR863903), Lai Duc Hamlet was attacked by an estimated two VC platoons. The 50th PF Plat was attacked when it entered the hamlet. Friendly losses were five KIA (two RF, one PSDF, and two civ) and two WIA. Enemy losses were unknown.

5. RGT Operations: On 1 Mar, 17 km West of Phu Cat (BR753482), elements of the 1st Regt, Capital ROK Inf Div (CRID), killed 14 enemy without friendly loss in Operation REE HO 20. On 5 Mar, 21 km west of Phu Cat (BR717516 and BR712475), element of Cav Regt, CRID in Operation BUN KAE 69-2 engaged forces in two contacts with results of six enemy KIA and four SA and 56 rounds of 60 and 82mm mortars. On 6 Mar, five km north of Binh Khe (BR7048), elements of the Cav Regt, CRID, engaged an unknown size enemy force. There were no friendly losses. Enemy losses were 12 KIA. On 8 Mar, 30 km west of Phu Cat (BR61471), elements of Cav Regt, CRID, killed five enemy and captured three SA on Operation BUN KAE 69-2. ROKs had one KIA. On 10 Mar, 12 km SW of Phu Cat (BR817427), elements of the Cav Regt, CRID, killed five enemy, captured three SA and 30 maps. Maps were drawings of ROK bases. On 14 Mar, 19 km north of Qui Nhon (CR068425), elements of the 1st Regt, CRID, captured 91 VC suspects. On the same day, five km NW of Phu Cat (BR63982), elements of the 1st Regt, CRID, captured 16 VC suspects. On 21 Mar, 15 km east of An Khe (BR65440), elements of the Cav Regt, CRID, killed six enemy and captured three SA during Operation BUN KAE 69-2. Friendly had negative casualties. Elsewhere, in Binh Dinh Province, ROK forces killed seven enemy and captured six SA in small units operations. On 22 Mar, 28 km SW of Phu Cat (BR652463), elements of the Cav Regt, CRID, killed six enemy and captured four SA in two contacts during Operation BUN KAE 3. On 29 Mar, nine km NE of An Khe (BR565480), elements of the CRID Cav Regt killed nine enemy and captured four SA during ambush operations without friendly casualties.

6. Others: On 10 Mar, ten km NW of Qui Nhon (CR022268), Phuc Long village was attacked by a VC company using small arms, automatic weapons and B-40 rocket fire. Friendly losses were seven KIA (two RF, five RD), 21 WIA (14 RF, five RD, two PSDF). Enemy losses were seven KIA and four SA captured. On 22 Mar, four km north of Phu Cat (BR900508), Hoa Hoi Hamlet was attacked by unknown number of enemy who burned 20 houses which resulted in 120 homeless. Hamlet was attacked by an unknown size enemy force resulting in one PSDF KIA.

CONFIDENTIAL

CONFIDENTIAL

AVFA-GC-OT

15 May 1969

SUBJECT: Operational Report of Headquarters, I FFORCEV for Quarterly Period Ending 30 April 1969 RCS CSFOR-65 (R1) (U)

and one PSDP WIA. Artillery supported. Enemy losses are unknown. On 23 Mar, two km NW of Qui Nhon (CRO65260), PRU was attacked by an estimated enemy company. The 117 RF Co reacted and US Artillery supported. Friendly results were three KIA and two WIA. Enemy losses were unknown.

(f) Binh Dinh Operations - April: Pacification support operations were the dominant activity as combined TOCs were established by US battalions at district level. This enabled the district chief to allocate military resources to pacification programs, improved the reaction to VC incidents, and reduced lead time for clearance of fires. Tactical operations continued to emphasize small unit patrols, blocking enemy efforts to disrupt pacification, and relieving PF and PP units of LOC security. The Volunteer Informat Program yielded over 100 rounds of artillery and mortar ammunition and assorted small arms ammunition.

1. US Operations: On 8 Apr six km NNW of Phu My at BR887726 Hawk Tm 13 C, 1st Bn, 503d Abn Inf engaged eight enemy with SA and ~~and~~. Enemy fled in unknown direction, losing two KIA, one PW (female), one Civ AM/FM radio, 250,000 piasters and misc documents which were extracted to LZ English. On 16 Apr, LZ English at BS879005 received 10-15 rounds of 82mm mortar in a helicopter park damaging nine UH1H aircraft. Mortars supported. On 19 Apr eight km North of LZ English at BS911110, Co D, 4th Bn, 503d Abn Inf detonated a booby trapped 105 howitzer round while establishing night location causing eight KIA (five US, two NP, one ARVN) and seven US WIA. On 25 Apr, seven km North of An Khe at BR535475, 4th Bn, 60th Arty bought the following munitions under the VIP: six rounds 105 HE, 20 rounds 105 WP, and four rounds 107mm EE.

2. RF/PP Operations: On 16 Apr at BS913102, 14 km NE of Borg Son, one platoon of the 540th RF Co on a road clearing operation was attacked by unknown size enemy force with SA and claymore. Reaction platoon arrived after contact broke. Results were four KIA (three PF, one Civ) and 12 WIA (four RF, eight Civ).

(g) Central Coastal Provinces Operations February: Spectacular results by ROK forces characterized operations in this area. Thirty-eight km SW of Tuy Hoa (BQ8425) the 3d Bn, 28th ROK Regt, 9th ROK terminated operation JUN MA 6 targeted against rear service units of the 5th NVA Div. The seven day operation resulted in 21 enemy KIA, one PW and 16 SA captured. Friendly casualties were two KIA. 27 km SW of Tuy Hoa (BQ9130), the 1st Bn, 28th ROK Regt terminated Operation UN MA 7 resulting in 30 enemy KIA, four PW's and 10 SA captured. ROKs had one KIA and two WIA. On 8 Feb, West of Dong Tre (BQ8879) elements of 26th ROK Regt, CAP ROK Inf Div, terminated Operation HAE SAN JIN 6 resulting in 107 enemy KIA, seven PW's 48 SA, nine CSW. ROKs had six KIA. The 4th Bn, 503d Abn Inf also participated in this operation.

1. US Operations: The 4th Bn, 503d Abn Inf participated in Operation HAE SAN JIN 6 previously discussed. US forces killed eight enemy and had eight of their own WIA. On 28 Feb in Nha Trang, a terrorist threw a HG into a crowd of US resulting in one KIA and 12 WIA (US).

2. ARVN Operations: On 6 Feb, 11 km SE of Tuy Hoa (CQ065435) elements of 2d Bn, 47th ARVN Regt ambushed an estimated enemy platoon resulting in four enemy KIA and two SA captured. Friendly had one KIA. On 23 Feb, 12 km west of Tuy Hoa (CQ0446), elements of 4th Bn, 47th ARVN Regt were attacked by an estimated enemy platoon resulting in six friendly WIA. Enemy losses are unknown.

CONFIDENTIAL

CONFIDENTIAL

AVFA-GC-OT

15 May 1969

SUBJECT: Operational Report of Headquarters, I FFORCEV for Quarterly Period Ending 30 April 1969 RCS CSFOR-65 (R1) (U)

3. ROK Operations: On 2 Feb, 25 km north of Ninh Hoa (BP9606), elements of the 9th ROK SF team engaged an unknown of enemy resulting in eight enemy KIA and two SA CIA. There were no ROK casualties. On 9 Feb, 16 km SE of Cung Son (BQ8526), elements of 3d Bn, 28th ROK Regt killed 11 enemy and captured seven SA, 196 HG, and 100 rucksacks. Seventeen km SW of Cung Son (BQ9236), elements of 1st Bn, 28th ROK Regt killed seven enemy and captured three SA. Friendly losses were one KIA and three WIA. On 20 Feb, 22 km west of Ninh Hoa (BP7479), elements of the 29th ROK Regt killed 19 enemy and captured three SA and eight rucksacks in Operation BAK JEE 2-6. Friendly had no casualties. On 22 Feb, 24 km SW of Nha Trang (BP8635), elements of the 30th ROK Regt engaged an unknown number of enemy killing 23, and capturing five SA and one CSW. Friendly had negative casualties. On 26 Feb, 25 km NW of Nha Trang (BP695709), elements of the 29th ROK Regt killed five enemy and captured two SA during Operation BAK JEE 2-6. Friendly had no casualties.

4. RF/PF Operations: On 11 Feb, the Thuan Man District headquarters and 503d RF Co at Cheo Reo received a mortar and B-40 rocket attack. Friendly losses were 24 KIA (20 RF, four civ), 33 WIA (27 RF, six civ). Enemy losses were seven KIA, one B40 and four SA. On 15 Feb, 15 km SW of Cheo Reo (BQ203644), the 752d RF Co engaged an estimated VC platoon believed to be en route to an arms cache. Thirteen enemy were killed without friendly loss. On 23 Feb, 10 km west of Nha Trang (BP9355), the 384th RF Co received 15 rounds of 82mm mortar fire resulting in two KIA (one civ), and 18 WIA (11 RF, seven civ). On 24 Feb, four km SW of Ninh Hoa (BP9377), a platoon received seven HG in its night position resulting in five KIA, (one PF, two RF, two civ), and eight WIA (three PF, one RF, one PSDF, three civ).

(h) Central Province Operations March: ROK operations characterized the majority of activity during the month. The two ROK divisions conducted a total of nine battalion and eight regimental size operations in their AO's. During the month, an intensive psyops campaign resulted in 50 small arms being turned over by the people. ROK forces killed 462 enemy and captured 250 small arms during the month.

1. US Operations: On 3 Mar, Cam Ranh Bay (CPO57145) received 28 rds of mortar and 140mm rocket fire near the pier (22d Repl Bn and 35th Engr Gp). Friendly losses were two KIA (one US, one civilian), three WIA (two US, one ROK), one 5 ton truck and one panel truck destroyed. Enemy losses were unknown. On 14 Mar, 12 km west of Ninh Hoa (BPO50830) the 48th AHC received 10-15 rounds of 82mm mortar resulting in one UH-1H destroyed and one UH-1H and UH-1B damaged. On 20 Mar, at Dong Ba Thin (CPO30295), the 92d AHC received 30 rounds of 82mm mortar resulting in 12 UH-1H's damaged. The 18th Engr Bde had three helicopters damaged.

2. ROK Operations: On 2 Mar, 29 km SW of Ninh Hoa (BP715676), elements of the 2d Bn, 29th Regt, 9th ROK Inf Div, killed five enemy and captured three SA during operation BAK JEE 2-6. On 3 Mar, 15 km SE of Tuy Hoa (CQ202322), elements of the 28th Regt, 9th ROK Inf Div in Operation JUN MA 7, engaged an estimated 25 VC during ambush operations. Enemy had 20 KIA and ten SA and one B-40 rocket captured. ROKs had no casualties. On 3 Mar, the 2d Bn, 29th Regt, 9th ROK Inf Div terminated Operation BAK JEE 2-6 SW of Ninh Hoa. Friendly losses

CONFIDENTIAL

CONFIDENTIAL

AVFA-GC-OT

15 May 1969

SUBJECT: Operational Report of Headquarters, I MFORCEV for Quarterly Period Ending 30 April 1969 RCS CSFOR-65 (R1) (U)

were three WIA. Enemy losses were 63 KIA, 41 detained and 21 SA captured. On 4 Mar, 21 km south of Tuy Hoa (CQ1428) elements of the 3d Bn, 28th Regt, 9th ROK Inf Div engaged an unknown number of enemy in four separate contacts. There were no friendly losses. Enemy losses were five KIA, one PW, and two SA captured. On 5 Mar, five km NE of Vung Ro (CQ319297), elements of the 28th Regt, 9th ROK Inf Div engaged an unknown size enemy force resulting in five enemy KIA and two SA captured. ROKs had negative casualties. On 8 Mar, seven km SW of Ninh Hoa (BP914742), elements of the 29th Regt, 9th ROK Inf Div had six contacts. Friendly losses were five KIA and 25 WIA. Enemy losses were unknown. On 9 Mar, 16 km NW of Vung Ro (CQ123276), elements of the 28th ROK Regt killed five enemy and captured three SA during ambush opns. ROK had negative casualties. On 10 Mar, seven km SW of Ninh Hoa (BR912739), elements of the 29th ROK Regt killed seven enemy and captured two SA during Operation BAK JEE 3-8. On the same day, elements of 30th ROK Regt 26 km NW of Nha Trang (BP843698), in Operation DONG BO 3-9 killed seven enemy and captured three SA. ROKs had no casualties. On 11 Mar, seven km SW of Ninh Hoa (BP915742) elements of the 29th ROK Regt in Operation BAK JEE 3-8 killed seven enemy and captured one SA and one CS weapon. ROKs had no casualties. On 13 Mar elements of 2d Bn, 28th ROK Regt had four separate contacts during Operation DO KAE BEE 2-6, 12 km NW of Tuy Hoa (CQ0653). There were no friendly losses. Enemy losses were 15 KIA and six SA captured. On 16 Mar, 22 km NW of Ninh Hoa (BQ893017), elements of the 29th ROK Regt in four contacts killed 15 enemy and captured two SA and a radio during Op BAK JEE 1-9. ROKs had no casualties. On 18 Mar, 30 km NW of Tuy Hoa (CQ0177) elements of the 26th ROK Regt killed seven enemy and captured five SA. ROKs had no casualties. On 19 Mar, five km east of Dong Tre (vic CQ002740), elements of the 26th Regt, CRID, killed seven enemy in two contacts and captured three SA. ROKs had one KIA from booby trap. On 21 Mar, 21 km NW of Tuy Hoa (BQ997597), elements of the 26th ROK Regt killed 12 enemy and captured six SA and three radios during Operation HAE SAN JIN 7. ROKs had no casualties. On 22 Mar, 23 km NW of Tuy Hoa (BQ962614) elements of the 26th Regt, CRID, killed five enemy and captured one SA during Operation HAE SAN JIN 7. ROKs had no casualties. On 28 Mar, 26 km SE of Tuy Hoa elements of the 28th ROK Regt killed seven enemy and captured two SA during Operation DO KAE BI 12. ROKs had one KIA.

3. ARVN Operations: On 7 Mar, 10 km west of Tuy Hoa (CQ113569), elements of 4th Bn, 47th ARVN Inf Regt detonated two pressure type mines resulting in one KIA and six WIA. On 10 Mar, 18 km south of Cheo Reo (BQ252603), elements of 3d Bn, 4th ARVN Inf Regt made contact with an estimated enemy company. Friendly results were three KIA and six WIA. Enemy losses were 16 KIA. On 14 Mar, Dong Xuan (BQ957807), the District HQ was attacked by an estimated reinforced platoon employing small arms, mortars, B-40s and satchel charges. Spooky supported. Friendly losses were two RF WIA, 20% damage to DIOCC and one house damaged. Enemy losses are unknown. On 20 Mar, 12 km west of Tuy Hoa (CQ040473), elements of the 47th ARVN Inf ambushed an enemy squad. There were no friendly losses. Enemy losses were five KIA, one SA and one CSW captured. On 25 Mar, 14 km SW of Tuy Hoa elements of the 1st Bn, 47th ARVN Regiment established contact with 80 VC carrying 15 wounded VC. Artillery and gunships supported. There were no friendly losses. Enemy losses were eight KIA, two 57mm RR and two 82mm mortars captured. On 26 Mar, vic CQ059402, 16 km SW of Tuy Hoa, an APC from D Co, 16th Arn hit a mine while transporting ARVN troops. Another APC stopped and a mine was

CONFIDENTIAL

CONFIDENTIAL

AVFA-GC-OT

15 May 1969

SUBJECT: Operational Report of Headquarters, 1 FFORCEV for Quarterly Period Ending 30 April 1969 RUC CSFOR-65 (R1) (U)

detonated when an ARVN jumped off. Friendly losses were two KIA (US), 17 WIA (three US, 14 ARVN). On the same day, 11 km west of Tuy Hoa (CQ055436), elements of the 1st Bn, 47th ARVN Regt, found five enemy in fresh graves. On 29 Mar, vic CQ059475, 11 km west of Tuy Hoa elements of the 4th Bn, 47th ARVN Regt engaged an enemy squad. There were no friendly losses. Enemy losses were seven KIA.

4. RF and PF Operations: On 14 Mar, 15 km SW of Tuy Hoa (CQ107357), a reconnaissance element from the 83d RF Co was attacked by an unknown number of enemy. Friendly losses were five RF WIA. Enemy losses were one KIA and one SA captured. On 18 Mar, two km south Song Cau (CQ068874) a PSDF unit near Long Phuoc Village was attacked by an estimated enemy squad. Friendly losses were eight KIA and nine WIA. Enemy losses were one KIA and one SA captured.

5. CIDG Operations: On 7 Mar, three km west of Dong Tre (BQ897738), a platoon size element of Dong Tre CSF attacked an unknown enemy size force. Friendly had negative casualties while killing 20 enemy and capturing ten SA. On 18 Mar, 20 km SE of Buon Blech, a Buon Blech CSF company established contact with an estimated enemy battalion. Friendly losses were five KIA, four MIA, and 10 weapons lost. Enemy losses were 20 KIA.

6. Other: On 1 Mar, 20 km south of Tuy Hoa (CQ222174), a train hit a mine and derailed. One civilian was KIA. The engine had major damage and one box car was destroyed. On 4 Mar, 12 km west of Nha Trang, a train was mined vic ER917510 with two pressure type mines. Friendly losses were four KIA (three children, one woman), nine WIA (two ARVN, seven civilians). On 16 Mar, 20 km NE of Dong Tre (CQ018740), a train was blown by a command detonated mine resulting in one PF KIA, and four WIA (two PF and two civilians).

(i) Central Provinces Operations - April: Activity generally receded from the higher level of March permitting more resources to be allocated to pacification support operations. ROK Operation DO KAE BEE 12, NW of Tuy Hoa resulted in 147 enemy KIA and 50 weapons captured, with losses of 10 KIA and 11 WIA. Success of the Volunteer Informant Program was such that one regiment received over 40 weapons in a ten day period.

1. ROK Operations: On 12 Apr, 16 km west of Tuy Hoa vic BQ993483, elements of 28th ROK Regt reported four enemy contacts. Friendly losses were five KIA, four WIA. Enemy losses were 29 KIA, seven SA, three CSW, and 15 documents captured. Thirty km west of Nha Trang elements of 29th ROK Regt reported two enemy contacts resulting in 26 enemy KIA and nine SA captured with no friendly loss. On 17 Apr during ROK Op DO KAE BEE 12, 21 km WNW of Tuy Hoa vic BQ9356, the 28th ROK Regt killed 21 enemy and captured five SA with friendly losses of one KIA and two WIA.

2. RF/PF Operations: On 4 Apr, five km west of Tuy Hoa at CQ101488 RD Team 5 and 37th PF Plat entered Xuan Hoa Hamlet and received effects of a command detonated claymore causing nine KIA (7 RD, 2 PF) and nine WIA (5 RD, 4 PF). On 26 Apr, 16 km NW of Cung Son at BQ782575, the 75th PF Plat was ambushed by a VC platoon using SA and AW. PF returned fire and the 130th PF plat reacted. Friendly losses were 10 KIA, six WIA, one MIA and 10 M16. Enemy losses are unknown.

CONFIDENTIAL

CONFIDENTIAL

AVFA-GC-01

15 May 1969

SUBJECT: Operational Report of Headquarters, 1 FFORCEV for quarterly Period Ending 30 April 1969 RCS CSFOR-65 (R1) (U)

2. Other Operations: On 20 Apr, five km south of Ninh Hoa at BP964756, PSDF and RD Team 20 were attacked by an unknown size enemy force. The 37th PF Plat and ARVN and ROK Artillery supported. Friendly losses were seven KIA (two RD, three PSDF, two civ), 21 WIA (eight RD, one PSDF, 12 civ), three SA lost. The enemy lost two KIA. At BP905677, 15 km SW of Ninh Hoa, elements of 30th ROK Regt killed five enemy and captured two SA with friendly loss. On 21 Apr, eight km NW of Ninh Hoa at BP860865, the Lam Song Training Center at Duc May was attacked by three sapper platoons supported by 70-80 rounds of 82mm mortar fire. Sappers penetrated up to 200 meters inside the perimeter despite friendly security (LP's and ambushes), and set satchel charges. Friendly forces engaged with SA and Artillery. Elements of the 4th Bn, 53d ARVN Regt swept area after contact. Friendly losses 46 KIA, 137 WIA (55 serious), 13 structures damaged. Enemy losses were two KIA, one AK47 and 20 satchel charges captured. On 21 Apr, Nha Trang Airbase at CP035523 received six rounds of 75mm RR, while the adjacent 5th SFGA Compound received two rounds of 75mm RR. Artillery supported. The results of both actions was two US WIA, 10 A/C damaged (five UH1, two V1A, one OV-1, one O-1, one U-21), and four structures damaged (one hanger and three buildings).

(j) Southern Provinces Operations February: Activity in the five southern provinces remained at a constant low level of intensity throughout most of the month. The majority of enemy initiated incidents were squad and platoon size attacks against territorial forces with the intent of harassment rather than overrunning the positions. Enemy activity increased beginning 22 Feb, to include both light and heavy standoff attacks against US and Vietnamese installations and civilian population centers such as Phan Rang, Phan Thiet and DaLat. In combined operations with the 23d ARVN division, several large caches were discovered during the period.

1. US Operations: The 3d Bn, 503d Abn Inf, began Search and Clear HANCOCK KNIGHT on 1 Feb. This operation was targeted against elements of the 3d Trans Gp and rear services section of Lam Dong Province and known enemy forces, several caches were found by the friendly elements. The operation terminated 12 Feb. Friendly losses were one KIA and one WIA. Enemy losses were seven KIA, 750 pounds of rice, four SA, 42 rds, 82mm mortar, 97 rounds, 60mm mortar, 123 B40 and B41 rockets, 34 rounds of 75mm RR, 5100 rounds of SA ammunition rounds captured. Three hundred pounds of rice were destroyed. Also on 1 Feb, C and D Cos, 3d Bn, 506th Inf (Amb1) initiated Operation HANCOCK EAGLE with two companies of 4th Bn, 44th ARVN Regt, north of Phan Thiet (vic AN9031). This operation was targeted against the 186th MF Bn and rear service elements of MR-6. B Co, 3d Bn, 506th (Amb1) Inf, joined the operation on 5 Feb, and the 44th ARVN Regt elements left on 2 Feb. As with Operation HANCOCK KNIGHT, only minor contact was made with enemy forces; however, several large food caches were discovered including one which contained six tons of rice. The operation terminated on 12 Feb. US losses were one KIA and 32 WIA. Enemy losses were 52 KIA, five PW, one CSW, 19 SA, 110 B40 rockets, 18 B41 rockets, 27 rounds of 75mm RR, 27 rounds of 60mm mortar and 30 tons of rice. ARVN losses were four WIA. Nine enemy KIA were credited to ARVN. On 22 Feb, Phan Rang Air Base (BN7746) received 61 rounds of 82mm mortar fire resulting in five friendly WIA, seven C-123 aircraft damaged (four heavy, three light), one HC-43 helicopter damaged (minor), two C47 aircraft damaged (minor) and two buildings damaged (minor). Also on 22 Feb, 3 km south of Phan Thieu, LZ Betty (AN803068)

CONFIDENTIAL

CONFIDENTIAL

AVFA-GC-OT

15 May 1969

SUBJECT: Operational Report of Headquarters, I FFCRCEV for Quarterly Period Ending 30 April 1969 RCS CSPOR-65 (R1) (U)

received a mortar and ground attack in which the enemy penetrated the perimeter. Friendly results were two KIA and 29 WIA. Enemy losses were 12 KIA, one PW and 29 hand grenades CIA. On 27 Feb, D and C Cos 3d Bn, 506th Inf (Ambl) initiated Operation HANCOCK EAGLE II/DAN AN 17 with 1st Bn, 53d ARVN Regt NE of Phan Thiet (vic BNO228) targeted against enemy elements in the Le Hong Phong Forest area. Through the end of Feb, results were three US WIA and one En KIA. ARVN results were negative.

2. ARVN Operations: In Tuyen Duc Province, elements of the 2d Bn, 53d ARVN Regt in Operation DAN AN 12/B found a cache containing 19.5 tons of rice (BN233762) SE of Duc Trong. Thirty km NE of Phan Thiet, the 1st Bn, 44th ARVN Regt were attacked (vic AN997343) while conducting a convoy move. Friendly losses were 15 KIA and 23 WIA. Enemy losses were seven KIA, nine SA and 2 CSW CIA.

3. ROK Operations: In Ninh Thuan Province, the 1st Bn, 30th ROK Regt initiated Search and Clear Operation KUN MA 12 NE of Phan Rang in Base Area 19 (BN9287), targeted against local force elements. This operation began on 5 Feb, and ran for ten days. Friendly losses were two KIA, and four WIA. Enemy losses were 80 KIA, 24 SA, seven CSW and two ton rice CIA.

4. RF and PF Operations. On 22 Feb, the 510 RF Co engaged an estimated enemy company at AN860185, north of Phan Thiet. The 283 and 300 RF Cos, one company of 4th Bn, 44th ARVN Regt, and elements of 1st Bn, 69th Arm reacted to encircle the enemy force and cut off its withdrawal routes. Friendly losses were three KIA, 11 WIA. Enemy losses were 67 KIA, three PW, 21 SA and four CSW CIA. On 25 Feb, SW of Duc Lap, Bon Sar Pa Outpost (YU805755) received 40 rounds of 82mm mortar. Friendly losses were one KIA and 28 WIA.

(k) Southern Provinces Operation March: Elements of Task Force South began the month by capturing a 204 ton rice cache. US and ARVN forces conducted combined operations in the Le Hong Phong Forest area SW of Song Mao. A massive psyops campaign, saturation patrolling, and the capture of large stores food have induced significant number of people to rally under the Chieu Hoi program. A total of 137 people turned themselves in including two VC hamlet chiefs. Elements of TF South and 23d ARVN Div killed 102 enemy during the month.

1. US Operations: On 1 Mar, 23 km SW of Bao Loc (ZT835553), elements of the 3d Bn, 503d Abn Inf discovered eight houses filled with rice. The rice cache weighed 204 tons. On 5 Mar, 22 km NW of Phan Thiet (ZT250250), elements of B Co, 3d Bn, 506th Abn Inf (Ambl) engaged unknown size enemy forces during Operation HANCOCK QUEEN. Friendly losses were 13 WIA. Enemy losses were one KIA. On 14 Mar, the Logistical Support Base near Phan Rang Air Base (BN773847) received 19 rounds of 82mm mortar resulting in two US WIA and one 3/4 ton truck and trailers damaged. On 15 Mar, Phan Rang Air Base (BN777862) received seven rounds of 107mm rockets. Gunships and artillery supported. No casualties or damage resulted. On 14 Mar, seven km NW of Phan Thiet (AN7615), elements of B Trp, 7th Sqd, 17th Air Cav engaged nine VC resulting in nine VC KIA. On 15 Mar, nine km NW of Phan Rang (BN758957), Phan Rang Air Base received six rounds of 107mm rocket. US artillery supported. One US was WIA, and no damage occurred. On 18 March, Phan Rang Air Base received four 107mm rockets which damaged two fuel trucks. No casualties occurred. On 21 Mar, Phan Rang Air Base received 20 rounds of 82mm mortar causing no casualties or damage. On 25 Mar, in Binh Tay Province

CONFIDENTIAL

CONFIDENTIAL

AVFA-GC-01

15 May 1969

SUBJECT: Operational Report of Headquarters, I FFORCEV for Quarterly Period Ending 30 April 1969 RCS CSFOR-65 (R1) (U)

40 km NW of Phan Thiet (ZT184501), the Recon Plat, 3d Bn, 503d Abn Inf discovered a 17 tons rice cache. On 27 Mar, 23 km west of Phan Thiet (ZT142156), elements of B Trp, 7th Sqdn, 17th Air Cav found 20 B-40 rockets. A short time later, a contact developed resulting in three friendly WIA and eight KIA and two SA captured. On 29 Mar, vic AN736291, 20 km NW of Phan Thiet, Co C, 3d Bn, 506th Abn Inf discovered a weapons cache containing six SA, two PRC-10 radios, a 57mm RR, one LMG, 19 B-40 rockets, 16 RPG rounds, five 60mm mortar rounds and five homemade bombs.

2. ARVN Operations: On 8 Mar, 28 km NE of Phan Thiet (AN933329), elements of the 1st Bn, 53d ARVN Inf Regt found 4400 lbs of salt in two caches. On 8 Mar, 28 km NE of Phan Thiet (AN977378), elements of 4th Bn, 44th ARVN Inf Regt attacked a VC squad. Friendly losses were one WIA. Enemy losses were four KIA and three captured. On 14 Mar, seven km north of Phan Thiet (AN812713), elements of 1st Bn, 44th ARVN Inf Regt repelled an attack by an estimated enemy company. The 2d Bn, 44th ARVN Inf and elements of the 1st Bn, 69th Arm reinforced. Friendly losses were three KIA (one RF, two ARVN) and 11 WIA (four RF, seven ARVN). Enemy losses were seven KIA, five PW's and four SA captured. On 31 Mar, vic BN242343, 10 km SW of Song Mao elements of the 1st Bn, 53d ARVN Regt found a seven ton rice cache.

3. ROK Operations: On 8 Mar, four km NE of Phan Rang (AN833830), elements of the 30th ROK Inf Regt, 9th ROK Inf Div killed five enemy and captured four SA during ambush operations. ROKs had no casualties. On 26 Mar, vic BP783018, 23 km NW of Phan Rang elements of the 1st Bn, 30th ROK Regt killed 19 enemy in five contacts during Operation DONG BO 5. On 28 Mar, 25 km NW of Phan Rang (BP737029), elements of the 30th ROK Regt killed 11 enemy and captured four SA. ROKs had one WIA. On 30 Mar, vic BP928735, eight km SW of Ninh Hoa elements of the 29th ROK Regt ambushed an enemy squad. ROKs had no casualties while killing five enemy and capturing five SA.

4. Other: On 19 Mar, eight km NW of Phan Thiet (AN760115), a Province Intelligence Team ambushed an estimated VC platoon. Gunships, artillery, and "Shadow" supported. Enemy withdrew to Van Lam Hamlet where contact resumed. Friendly losses were two KIA and two Civ WIA (caught in crossfire). Enemy losses were five KIA and three SA captured. On 22 Mar, the PSDP compound in Phan Thiet (AN838096) received ten B-40 rockets resulting in four KIA and seven WIA. Enemy losses are unknown.

5. CIDG Operations: On 19 Mar, seven km SW of Nha Trang CSF A-502 was engaged by an unknown number of enemy. Artillery supported. Friendly losses were 13 CIDG WIA. Enemy losses were two SA captured.

6. RF and PF Operations: On 7 Mar, five km SE of Song Mao (BN310395), the 59th PF Plat was engaged by an estimated enemy company. The 7th PF Plat reinforced. Friendly losses were one KIA, one WIA and two SA lost. Enemy losses were four KIA. On 9 Mar, five km SW of Phan Rang (BN785745), the 134th RF Co at Tu An Hamlet was attacked by two enemy platoons. Artillery and Spooky supported. Friendly losses were three KIA and one WIA. Enemy losses were seven KIA and two SA captured. On 10 Mar, three km south of Song Mao (BN263413), elements of the 85th PF Plat accidentally detonated a cluster of hand grenades. One was killed and six were wounded. On 10 Mar, four km SW of Phan Rang (BN785745), the 134th RF Company was attacked by an estimated two VC platoon. ARVN Artillery supported. Friendly losses were three KIA and one WIA. Enemy

CONFIDENTIAL

CONFIDENTIAL

AVFA-GC-01

15 May 1969

SUBJECT: Operational Report of Headquarters, I FFURCEV for Quarterly
Period Ending 30 April 1969 RCS CSFUR-65 (R1) (U)

losses were two KIA and two SA captured. On the same day, 20 km south of Dalat (BP182029), the 47th PF Platoon and RD Team 7 were attacked by an unknown number of enemy. Friendly losses were two KIA and five WIA. Enemy losses were two KIA and two SA captured. On 12 Mar, four km NE of Bao Loc (ZP110/75), the 16th PF Plat in Tham Huong Hamlet were attacked by sappers. Four bulldozers were destroyed and two more were damaged. On 18 Mar, seven km NE of Phan Rang (BN865835) the 116 RF Co was engaged by an unknown enemy size force. Friendly losses were one KIA, four WIA, one SA lost. Enemy losses were unknown. On 18 Mar, seven km NE of Phan Rang (BN865835), the 116th RF Co was engaged by an unknown size enemy force. Friendly losses were one KIA, four WIA, and one SA lost. Enemy losses were unknown. On 20 Mar, five km SE of Song Mao (ZAO65349), the Hoa Da District Headquarters and 296 RF Co received mortar and B-40 rocket attack. Friendly losses were five WIA. Enemy losses were five KIA. On 20 Mar, ten km south of Dalat (BP238099), the 153d RF Co and RD Team 10 were attacked by an unknown number of enemy. Friendly losses were three KIA and eight WIA. Enemy losses were two KIA and one SA captured. On 21 Mar, 14 km north of Phan Thiet (AR869285), Tho Giao District Headquarters received mortar and ground attack from an estimated enemy battalion. The 88th RF Co and 31st, 33d and 24th PF Plats defended. Artillery and mortars supported. Friendly losses were two KIA and 13 WIA (three US, nine RF, one PF). Enemy losses were 35 KIA, nine SA and seven CSW captured. On 21 Mar, seven km NE of Phan Thiet (AN885131), the 75th PF Plat established contact with an estimated enemy platoon. Artillery and mortars supported. There were no friendly losses. Enemy losses were seven KIA and four SA captured. On 22 Mar, 22 km SW of Dalat (AP960140), a claymore mine was detonated against the 57th PF Plat and civilians. Friendly losses were one KIA (PF) and seven WIA (four PF, three civ). On 23 Mar, two km NE of Bao Loc (ZT087799), Con Hinh Da Hamlet and the 10th PF Plat were attacked by an unknown enemy size force who killed the hamlet chief, three PF, and burned 11 houses. Five SA were also lost. Enemy losses are unknown. On 24 Mar, ten km NW of Phan Thiet (AN738128) the 785th RF Co was attacked by an estimated enemy platoon which was supported by 60mm mortars. Friendly losses were six KIA and five WIA. Three enemy SA captured. On the same day, seven km SE of Song Mao (BN333384), the 296 RF Co received an unknown number of 60mm mortar and B-40 rocket fire. Friendly losses were ten KIA and four WIA. Enemy losses were unknown. On 27 Mar, four km south of Song Mao (BN280395), elements of 118th RF Co ambushed an enemy squad resulting in five enemy KIA and two SA captured. PF had negative casualties. On 28 Mar, seven km SE of Song Mao, the 140th RF Co was attacked by an unknown number of enemy. ARVN artillery supported. Friendly losses were one KIA, six WIA. Enemy losses were unknown. On the same day, 11 km north of Phan Thiet (AN800212), the 28th PF Plat detonated a 4.2mm mine resulting in one KIA and four WIA. On 29 Mar, vic YT928638, 19 km SW of Bao Loc the 341st RF Co at Dan Rai Hamlet received a B-40 attack. Friendly losses were one RF KIA, one RF WIA and five civilians WIA. Enemy losses were unknown. On 30 Mar, vic AN729139, 16 km NW of Phan Thiet, the 785th RF Co received 18 mortar rounds at Muong Mau Hamlet. Friendly losses were one civilian KIA and 11 civilians WIA. Enemy losses were unknown.

(1) Southern Province Operations - April. Pacification support and small unit operations continued to receive the major emphasis with ROK forces conducting over 200 operations a day as the month ended. Operation BONG HO 5, conducted by the 30th ROK Regt NW of Phan Rang resulted in 19 enemy KIA and 59 weapons captured at a cost of four friendly WIA.

CONFIDENTIAL

CONFIDENTIAL

AVFA-GC-OT

15 May 1969

SUBJECT: Operational Report of Headquarters, I FFORCEV for Quarterly
Period Ending 30 April 1969 RCS CSFOR-65 (R1) (U)

1. US Operations: On 7 Apr, 12 km SE Bao Loc at ZT160732, 1st Plt, Co B, 3d Bn 503d Abn Inf was attacked in its night location. The enemy attacked from the south with SA, AW, HG, M-79, and 60mm mortar fire. The US unit fired a claymore and withdrew to a tight perimeter. Artillery supported. Casualties for the 25 man platoon were 11 KIA and 13 WIA. Action commenced at 07630H and terminated at 070700H. Co C, 3d Bn, 503d Abn Inf was inserted at 0845H and later found an unoccupied battalion size base camp 300 meters east of the action. Base camp was horseshoe shape, open end west, 150 meters wide and 200 meters long, and consisted of 70-80 bunkers. Camp, estimated to be three days old, contained two B40 rockets, unknown number of ChiCom grenades, and miscellaneous documents to include Co roster and two diaries. Co A (-), 3d Bn, 503d Abn Inf and Trp B, 7th Sqdn, 17th Air Cav searches had no results.

2. ROK Operations: On 1 Apr, 29 km NW of Phan Rang (BP717067), during Operation DONG HO 5 elements of the 30th ROK Regiment, 9th ROK Div, established several enemy contacts, resulting in one friendly WIA, and enemy losses of 102 KIA, 29 SA, 12 rounds 107mm rockets, five bangalore torpedoes, 27 AP mines, 25 B40 rounds, 67 rounds 82mm mortar, one PRC-10 radio, and one starlight scope captured. On 2 Apr, 31 km NW of Phan Rang (BP729081), the same unit had three more contacts resulting in one ROK WIA and 19 enemy KIA and 5 SA captured.

3. ARVN Operations: On 16 Apr, 30 km NE of Phan Thiet at BN010354, 2d Sqdn, 8th ARVN Cav APC troop escorting an ARVN convoy was attacked by an enemy force using SA, AW, B40 rockets, and 82mm mortar. Gunships and Artillery supported, and 3d Bn, 44th ARVN Regt swept the area. Friendly losses were one KIA, 19 WIA, one APC and one 2 1/2 ton truck damaged, while the enemy lost 29 KIA, one B41 rocket launcher, one B40 rocket launcher, one caliber .50 machine gun and 12 SA captured.

4. Other Operations: On 18 Apr, the Cam Ly Airfield and 301st RF Co at Dalat (BP185220) received 40-45 rounds of 82mm mortar followed by a ground attack by an enemy force employing B40, SA, and satchel charges. PRU Team swept, supported by US and ARVN artillery. Friendly losses were two KIA, one WIA, 57,000 gallons JP4, 4,000 gallons AVGAS (entire POL stock), and one O-1 aircraft and three conexs of WP rockets destroyed. Enemy losses were two KIA and four SA captured. On 23 April, in Dalat (BP213210), three delay-fuze satchel charges were detonated, one in the home of the Vice-Chief of Police, one in a jeep outside, and one in a civilian home. Four civilians were killed, 1 - US and five civilians were wounded, one house was heavily damaged, and jeep was destroyed.

(m) Results for II CTZ for the period 1 Feb 69 to 30 Apr 69.

a. Friendly

	US	ROK	ARVN	RF/FF	CIDG	OTHER	TOTAL
KIA	46	27	96	128	22	19	339
WIA	327	40	290	369	116	67	1209
MIA				5		21	26

CONFIDENTIAL

CONFIDENTIAL

AVFA-GC-OT 15 May 1969
SUBJECT: Operational Report of Headquarters, I FFORCEV for Quarterly
Period Ending 30 April 1969 RCS CSFOR-65 (R1) (U)

b. Mar 69

	US	ROK	ARVN	RF/PF	CIDG	OTHER	TOTAL
KIA	144	29	78	138	52	69	510
WIA	781	63	253	451	134	101	1783
MIA	6			25	4	6	41

c. Apr 69

KIA	45	17	44	88	15	81	290
WIA	260	41	161	217	68	220	967
MIA			2	9	1	8	20

d. Feb - Mar 69

KIA	235	73	218	354	89	169	1139
WIA	1368	144	704	1037	318	388	3959
MIA	6		2	39	5	35	87

2. Enemy (VC/NVA) - See paragraph 1b (4) (a)

(3) Organization and Training Activities:

(a) All units that were assigned or under the operational control of this headquarters as of 31 Jan 69 are listed at Incl 3.

(b) The command relationship among II Corps, ROKFV-FC, I FFORCEV and major U.S. units within II CTZ is at Incl 4.

(c) The following units were assigned to I FFORCEV during the period:

1. Camp Radcliff Augmentation Security Detachment (Prov) assigned by USARV GO 1592, 5 May 69.

2. 1st Chem Det (CEHC) assigned by USARV GO 1023, 24 Mar 69.

3. 32d CS Chap Det assigned by USARV GO 542, 16 Feb 69.

(d) The following unit was reassigned from I FFORCEV during the period: 62d Sig Det (Avionics) assigned to 2d Armd Sqdn, 1st Cav by USARV GO 331, 29 Jan 69 as amended by USARV GO 602, 19 Feb 69.

(e) Headquarters, I FFORCEV Prov Arty Gp was organized by I FFORCEV GO 192, 5 Apr 69. This headquarters consists of 11 officers and 26 enlisted men. The mission of the unit is to provide tactical control and selected administrative and logistical supervision of I FFORCEV Artillery units within AO DAN AN/SHERIDAN.

CONFIDENTIAL

CONFIDENTIAL

AVFA-GC-OT

15 May 1969

SUBJECT: Operational Report of Headquarters, I FFORCEV for Quarterly
Period Ending 30 April 1969 RCS CSFOR-65 (R1) (U)

(f) Manpower Authorizations:

1. Camp Radcliff Augmentation Security Det was organized by USARV GO 1142, 3 Apr 69.
2. Co E, 20th Inf (LRP) was redesignated and reorganized as Co C (Ranger), 75th Inf by USARPAC GO 66, 27 Jan 69.
3. I FFORCEV Prov Arty Gp was organized by I FFORCEV GO 192, 5 Apr 69.
4. 1st Bn (155mm) (T), 92d Arty and 6th Bn (155mm) (T), 84th Arty were reorganized under MTOE G-425G PAC 1/69 by USARPAC GO 157, 20 Feb 69.
5. 2d Armd Sqnd, 1st Cav was reorganized under MTOE 17-105G, PAC 1/68 by USARPAC GO 93, 31 Jan 69.
6. 4th Bn (AW) (SP), 60th Arty was reorganized under MTOE 44-85G, PAC 1/68 by USARPAC GO 239, 26 Mar 69.
7. 6th Bn (8"/175mm) (SP), 14th Arty and 6th Bn (8"/175mm) (SP), 32d Arty were reorganized under MTOE 6-435G, PAC 1/69 by USARPAC GO 148, 18 Feb 69.
8. 7th Bn (8"/175mm) (SP) 15th Arty was reorganized under MTOE 6-435G PAC 1/69 by USARPAC GO 143, 18 Feb 69.
9. 32d CS Chap Det was organized under MTOE 29-500G, PAC 1/69 by USAR PAC GO 72, 28 Jan 69.
10. 41st CA Co was reorganized under MTOE 41-500D, PAC 5/69 by USARPAC GO 893, 26 Dec 68.
11. HHB 41st Arty Grp and HHB 52d Arty Grp were reorganized under MTOE 6-401G, PAC 1/68 by USARPAC GO 34, 16 Jan 69.
12. 77th, 237th, 241st, 242d, 243d, 244th, 253d, 254th, 255th and 256th FA Det were reorganized under MTOE 6-517T, PAC 1/69 by USARPAC GO 116, 12 Feb 69.

(g) Research and Development (R&D) Activities: Requests for information on R&D items from USARV and activities monitored by this headquarters. There were no requests for ENSURE (Expediting Non-Standard Urgent Requirements for Equipment) items received from assigned, attached or OPCON units. No ENSURE requests were submitted to USARV from HQ, I FFORCEV.

(h) Training: Assigned and attached units, less artillery groups and battalions, are inspected semi-annually. Seven units were inspected during the past quarter and all were rated satisfactory.

CONFIDENTIAL

CONFIDENTIAL

AVFA-GC-OT

15 May 1969

SUBJECT: Operational Report of Headquarters, I FFORCEV for Quarterly
Period Ending 30 April 1969 RCE CSFOR-65 (R1) (U)

(i) Doctrine: The "Tactical Notes" publication has been given a new look. This new look presents the notes in a different format and style along with drawings to make the notes more readable and more instructive. These Tactical Notes are attached as inclosures to this ORLL.

1. Tactical Notes for Feb 1969. (Inclosure 5)
2. Tactical Notes for Mar 1969. (Inclosure 6)
3. Tactical Notes for Apr 1969. (Inclosure 7)

(j) ARVN Improvement: During the month of April, I FFORCEV began to turnover equipment of a US artillery battalion to a newly activated ARVN artillery battalion. The 6th Bn, 84th Arty (155 Towed) started the turnover of equipment to the 45th ARVN Arty Bn on 10 Apr 1969. The equipment transfer is being completed in a successful manner. A smooth transfer was obtained by having several conferences to resolve problems and questionable areas in the turnover of equipment to ARVN and US personnel. The success of this equipment turnover can be attributed to the close cooperation and coordination of ARVN and US personnel. This first ARVN firing battery to receive US equipment is scheduled to be operational in July 1969. Other batteries within the 45th ARVN Arty Bn will complete transfer of equipment from the US battalion by August 1969.

(4) Chemical

(a) Herbicide operations during this reporting period have included both crop and defoliation missions. Unfavorable weather conditions throughout the II CTZ have resulted in the cancellation of 352 sorties of 689 sorties scheduled.

1. The results of US Air Forec UC-123 herbicide missions are as follows:

<u>PROVINCE</u>	<u>NO. OF SORTIES FLOWN</u>	<u>HECTARES DEFOLIATED</u>	<u>M/T CROPS DESTROYED</u>
Binh Dinh	60	7,272	0
Binh Thuan	0	0	0
Darlac	6	720	0
Khanh Hoa	0	0	0
Kontum	149	17,880	0
Lam Dong	0	0	0
Ninh Thuan	6	720	0
Phu Bon	0	0	0
Phu Yen	0	0	0
Pleiku	6	720	0
Quang Duc	110	13,420	0
Tuyen Duc	0	0	0
Total	337	40,632	0

CONFIDENTIAL
42

CONFIDENTIAL

AVFA-GC-OT 15 May 1969
 SUBJECT: Operational Report of Headquarters, I FFORCEV for Quarterly
 Period Ending 30 April 1969 RCS CSFOR-65 (R1) (U)

2. Units in II CTZ are continuing to use UH-1 and CH-47 helicopters and truck based power spray apparatuses to spray small areas not conducive to spray by UC-119 aircraft. The results of helicopter spray operations are as follows:

<u>UNIT</u>	<u>HECTARES DEFOLIATED</u>	<u>M/T CROPS DESTROYED</u>
HQ, I FFORCEV	102	0
ROKFV-FC	2241	68
4th Inf Div	475	.1
DSA, II Corps	2690	0
173D Abn Bde	1082	0
3d Bn, 506th Abn Inf (Ambl)	<u>0</u>	<u>0</u>
Total	6590	68.1

(b) Riot control agents (RCA) are being employed in both offensive and defensive operations. On 26 Feb, the 4th Inf Div employed six E-158 CS canister clusters vicinity ZA 170698. The drop was followed by an airstrike and resulted in 50 VC/NVA KIA. On 2 Mar 69, the 4th Inf Div employed two E-158s vicinity YB 760033. The drop was followed by fire from gunships and three airstrikes and resulted in six VC/NVA KIA, two 1½ ton trucks CIA, 61 rounds of 105mm HE (Chicom) CIA, 1200 lb of rice CIA, one protective mask CIA, and five secondary explosions. On 6 Mar 69 and 12 Mar 69, the 173d Abn Bde employed a total of 272 E-158 CS canister clusters in support of a large scale integrated CS, artillery and infantry operation. On 19 Mar 69, the 3d Bn, 506th Inf (Ambl), TF South, dropped 102 drums (8,160 lb) of CS to contaminate suspected enemy bases southwest of Phan Thiet, Binh Thuan. Naval gunfire and an airstrike at ZS 278978 resulted in three bunkers destroyed and one secondary fire.

(c) Personnel detectors (APD and MPD) operating within the II CTZ are providing a continual source of reliable information concerning enemy locations. In most instances, CS, gunships, TAC air or artillery fire was employed against the locations of the heavy readings. All readings were submitted to the appropriate G2/S2 for evaluation.

1. The summary of personnel detector operations in II CTZ is as follows:

<u>UNIT</u>	<u>APD MISSIONS</u>
ROKFV-FC	43
4th Inf Div	270
173d Abn Bde	52
3d Bn, 506th Inf (Ambl)	12
3d Bn, 503d Abn Inf	2

CONFIDENTIAL

AVFA-GC-OT 15 May 1969
SUBJECT: Operational Report of Headquarters, I FFORGEV for Quarterly
Period Ending 30 April 1969 RCS CSFOR-65 (R1) (U)

<u>UNJT</u>	<u>APD MISSIONS</u>
23d ARVN Div Advisory Tm	57
IDC Nha Trang	<u>8</u>
Total	444

2. Selected personnel from CAP ROK Inf Div and 9th ROK Inf Div are supporting combat operations in ROK AOs. The 23d ARVN Div continues to be supported by US Advisory personnel detector operations. The 173d Abn Bde and 4th Inf Div will support the 22d ARVN Div until personnel are trained.

3. On 11 Feb 69, the MPD mission aircraft (an O1) from the 173d Abn Bde received fire and crashed and burned vicinity of BR 840735. The pilot was killed and the MPD operator received several bone fractures. On 11 Mar 69, the MPD mission aircraft from the CAP ROK Inf Div crashed vicinity BQ 961787 while returning from a mission. The US crew and the ROK operator were killed and the aircraft and detector destroyed. On 21 Mar 69, the SCORPION (APD and gunships) team from the 4th Inf Div received enemy fire vicinity YA 807518 and returned it, resulting in eight VC/NVA KIA. Found in the area was a small base camp.

(d) The enemy continued to use riot control agents on a small scale during offensive operations. There have been 12 reported enemy initiated actions during which the enemy has used riot control agents. Eleven were mortar attacks. Ten of the mortar incidents occurred during the period 4 - 13 Mar 69, west of Poley Kleng, Kontum. One mortar incident occurred at LZ Schueller vicinity BR 36244572 on 21 Mar 69. No casualties or damage were attributed to the mortar rounds which contained the CS type agent. On another occasion, the VC/NVA contaminated 800m of Highway QL 19 with powdered CS. The road was decontaminated by flushing the area with water.

(5) G3 Air Operations:

(a) There were a total of 6089 tactical air sorties (4067 pre-planned sorties and 2022 immediate) averaging 66.5 per day. These sorties were flown in the following target categories:

1. Troops in Contact (TIC) - 864 sorties
2. Confirmed Enemy Locations (CEL) - 1309 sorties
3. Acquired Enemy Locations (AEL) - 984 sorties
4. Suspected Enemy Locations (SEL) - 1590 sorties
5. Fixed Target Destruction (FTD) - 579 sorties
6. Troop Assault Preparation (TAP) - 338 sorties
7. Landing Zone Clearing (LZC) - 425 sorties

(b) Of the total sorties flown this quarter, 3842 were in support of US/FWMAF operations in II CTZ with the following results:

CONFIDENTIAL

CONFIDENTIAL

AVFA-GC-OT

15 May 1969

SUBJECT: Operational Report of Headquarters, I FFORCEV for Quarterly
Period Ending 30 April 1969 RCS CSFOR-65 (R1) (U)

SORTIES/

<u>OPERATION</u>	<u>SORTIES</u>	<u>DAY</u>	<u>REMARKS</u>
4TH INF DIV	2186	24	62 KBA (Conf), 18 KBA (est), 308 secondary explosions, 96 secondary fires, 287 bunkers destroyed, 36 bunkers damaged, one cave destroyed, 123 bunkers uncovered, 10 bridges destroyed, five bridges damaged, three spider holes destroyed, 78 roads cut, 42 structures destroyed, 28 structures damaged, two trails cut, 49 foxholes destroyed, 170 feet trench destroyed, two tunnels destroyed, one tunnel uncovered, six A/W positions destroyed, six 12.7mm AA positions destroyed, one 57mm RR destroyed, one 37mm AA position destroyed, one 105mm How damaged, one 105mm How silenced, two 82mm mortar positions destroyed, one 100mm weapon position destroyed, six 50 cal MG positions destroyed, three 60mm mortar positions destroyed, two 60mm mortar positions damaged, 10 fortified positions uncovered, five 2½ ton trucks destroyed, and two 2½ ton trucks damaged.
TF SOUTH	260	3	14 KBA (Conf), seven KBA (est), three secondary explosions, 15 secondary fires, 183 bunkers destroyed, 38 bunkers damaged, 31 structures destroyed, one truck destroyed, 20 foxholes destroyed, 16 sleeping platforms destroyed, three tunnels uncovered, one cave uncovered and two trenches destroyed.
173D ABN BDE	301	3	Six KBA (est), 11 secondary explosions, three secondary fires, 12 bunkers destroyed, 12 bunkers damaged, four bunkers uncovered, 29 structures destroyed, 20 structures damaged, nine caves damaged and 10 caves uncovered.
9TH ROK DIV	380	4	19 KBA (conf), 16 secondary explosions, 35 secondary fires, 25 bunkers destroyed, one bunker damaged, 13 structures destroyed, one bridge destroyed, 33 caves destroyed, three caves damaged, one tunnel uncovered and one clothes cache destroyed.

CONFIDENTIAL

CONFIDENTIAL

AVFA-GC-OT 15 May 1969
 SUBJECT: Operational Report of Headquarters, I FFORCEV for Quarterly
 Period Ending 30 April 1969 RCS CSFOR-65 (R1) (U)

<u>OPERATION</u>	<u>SORTIES</u>	<u>DAY</u>	<u>REMARKS</u>
CAP ROK DIV	378	4	18 KBA (Conf), six KBA (est), 41 secondary explosions, 48 secondary fires, 14 bunkers destroyed, four bunkers damaged, 23 structures destroyed, two structures damaged, one road cut, three trails cut, two trenches destroyed, three trenches damaged, one boat destroyed, one 12.7mm AA position destroyed, four caves destroyed, four caves uncovered, 12 tunnels destroyed, three spider holes destroyed and one food cache destroyed.
IFFV	293	3	Four secondary explosions, 11 secondary fires, 15 bunkers destroyed and two structures destroyed.
OTHER	44	.5	Include 7th AF Special Interdiction Program. BDA included with 4th Inf Div totals.

(c) The remaining 2247 tactical air sorties flown in II CTZ were in support of GVN operations. Of the total sorties flown, 772 were in support of ARVN operations, 452 in support of CIDG operations and 1023 in support of Provincial Forces operations. Results were as follows: 158 KBA (Conf), 453 KBA (est), 187 secondary explosions, 342 secondary fires, 1257 bunkers destroyed, 201 bunkers damaged, 541 structures destroyed, 177 structures damaged, 21 caves destroyed, 39 caves damaged, three caves uncovered, 12 bridges destroyed, nine sampans destroyed, 61 tunnels destroyed, 27 tunnels damaged, two crop fields destroyed, 59 foxholes destroyed, 15 roads cut, 10 trails cut, one occupied AA position destroyed, 16 unoccupied AA positions destroyed, 11 unoccupied gun positions destroyed, 22 trenches destroyed, six dams destroyed, two dams damaged and three food caches destroyed.

(d) B52 Support:

1. There were 380 B-52 sorties flown this quarter in support of ground operations. Last quarter, there were 324 sorties.

2. A summary of support by Province and month is listed below.

	<u>Feb</u>	<u>Mar</u>	<u>Apr</u>	<u>Total</u>
Kontum	49	208	103	360
Darlac	0	0	1	1
Quang Duc	6	0	0	6
Binh Dinh	0	0	13	13
Total	55	208	117	380

CONFIDENTIAL

CONFIDENTIAL

AVFA-GC-OT

15 May 1969

SUBJECT: Operational Report of Headquarters, I FFORCEV for Quarterly
Period Ending 30 April 1969 RCS CSFOR-65 (R1) (U)

(6) Army Aviation Operations:

(a) The major objective in employing the tactical aviation assets available to I FFORCEV remains as stated in operational reports.

1. Provide air mobility to combat elements of FWMAF in II CTZ.
2. Provide aviation support to the province senior advisors and CORDS personnel in II CTZ for C&C and resupply.
3. Support the aerial reconnaissance and surveillance program.

(b) Resources available from 17th CAG are:

1. Assault helicopter assets (UH-1H "Slick"):

<u>UNIT</u>	<u>SUPPORT MISSION</u>
10th Combat Aviation Battalion	GS Southern Coastal, GS Southern Highlands and Task Force South, Recondo, 5th SF3(A), 23d ARVN Div, 9th ROK Inf Div.
48th AHC	
92d AHC	
155th AHC	
281st AHC	
52d Combat Aviation Battalion	GS Northern Highlands, Prairie Fire, 4th Inf Div, 24th STZ.
57th AHC	
119th AHC	
170th AHC	
189th AHC	
268th Combat Aviation Battalion	GS Northern Coastal, 173d Abn Bde, Cap ROK Inf Div, 22d ARVN Div.
61st AHC	
129th AHC	
134th AHC	

2. The 335th AHC remains OPCON to SA IV Corps as stated in last report.

3. The 7th Sqdn, 17th Air Cav remains assigned to 17th CAG OPCON to I FFORCEV and further OPCON to the 4th Inf Div, and is stationed at Camp Enari, II CTZ. B Trp, 7th Sqdn, 17th Air Cav is further OPCON to Task Force South and is located in Phan Thiet, II CTZ. C Trp 7th Sqdn, 17th Air Cav has been placed OPCON to 173d Abn Bde on 15 Apr 69 and is located at Lane AAF, An Son.

CONFIDENTIAL

CONFIDENTIAL

AVFA-GC-OT

15 May 1969

SUBJECT: Operational Report of Headquarters, I FFORCEV for Quarterly
Period Ending 30 April 1969 RCS CSFOR-65 (R1) (U)

4. Heavy helicopter assets:

<u>COMPANY</u>	<u>BATTALION</u>	<u>SUPPORT MISSION</u>
355th HHC	268th CAB	GS II CTZ

5. Assault support helicopter assets (CH-47 "Hook"):

<u>COMPANY</u>	<u>BATTALION</u>	<u>SUPPORT MISSION</u>
179th ASHC	52d CAB	GS 4th Inf Div
180th ASHC	268th CAB	GS Central Coastal
196th ASHC	268th CAB	GS Northern Coastal
243d ASHC	10th CAB	GS Southern Coastal

6. Armed Helicopter companies:

<u>COMPANY</u>	<u>BATTALION</u>	<u>SUPPORT MISSION</u>
238th Avn Co (E)	268th CAB	GS II CTZ
361st Avn Co (E)	52d CAB	GS II CTZ

7. The 183d, 185th, 203d and 219th Reconnaissance Airplane Companies support the visual reconnaissance program and provide GS throughout II CTZ.

8. The 225th Surveillance Airplane Company is employed throughout II CTZ in aerial surveillance roles.

9. The 18th Utility Airplane Company provides GS utility support throughout II CTZ and for XXIV Corps operation in the I CTZ.

(c) Major accomplishments:

1. Airmobile assets were provided to the following US operations for the periods indicated:

<u>OPERATION</u>	<u>SUPPORTED UNIT</u>	<u>DURATION</u>
DARBY CREST I-III	1st Bn, 503d Abn Inf	1 Feb - present
DARBY TRAIL I-II	2d Bn, 503d Abn Inf	1 Feb - present
DARBY MARCH II	4th Bn, 503d Abn Inf	1 Feb - 6 Mar
WAYNE ARROW	1st Bde, 4th Inf Div	1 Feb - 8 Feb
PUTNAM PANTHER	1st Bde, 4th Inf Div	1 Feb - present
HANCOCK EAGLE	3d Bn, 506th Inf (Aml)	3 Feb - 21 Feb

CONFIDENTIAL

CONFIDENTIAL

AVFA-GC-OT

15 May 1969

SUBJECT: Operational Report of Headquarters, I FFORCEV for Quarterly
Period Ending 30 April 1969 RCS CSFOR-65 (R1) (U)

<u>OPERATION</u>	<u>SUPPORTED UNIT</u>	<u>DURATION</u>
HANCOCK KNIGHT	3d Bn, 503d Abn Inf	4 Feb - 15 Feb
WAYNE GREEN	1st Bde, 4th Inf Div	11 Feb - 28 Feb
WAYNE GRAY	1st Bde, 4th Inf Div	1 Mar - 15 Mar
HANCOCK QUREN	3d Bn, 503d Abn Inf	4 Mar - 22 Mar
	3d Bn, 506th Inf (Ambl)	
WAYNE JAVELIN	1st Bde, 4th Inf Div	13 Mar - present

2. ROKA Forces were allocated (on a daily basis) one AHC per division. In addition, hook allocations were 3 daily to CRID and 1 daily to 9th ROK Inf Div. Additional support was provided on a mission basis for major airmobile operations. ARVN Forces in II CTZ received two AHC on a daily basis to support their airmobile operations.

3. Airmobile assets were provided to the following special operations directed by MACV: Prairie Fire, Project Delta, Recondo School.

4. Airmobile assets were provide to the following units or agencies on a general support basis.

I FFORCEV Staff	IDC - Nha Trang	II ALC (ARVN)
21st Sig Grp	MACV Engr	V ALC (ARVN)
18th Engr Bde	US Navy Spt Fac	CORDS - PSYOPS
Qui Nhon Spt Cmd	100th Log Cmd (ROK)	MACV
IFFV Arty	Cam Ranh Bay Spt Cmd	

d. (C) Logistical Activities

(1) Supply:

(a) The overall supply of troop requirements continues to be satisfactory. There are no shortages of supplies and equipment which significantly impair the operational capability of the command.

(b) Emphasis continued on the identification and retrograde of excess supplies during the period. A total of 4103 line items of excess supplies, valued at \$2,028,950, were retrograded during the period.

(c) The shortage of $\frac{1}{2}$ ton vehicles caused by the ARVN Modernization Program continued throughout most of the period; however, some vehicles were being released at the end of the period.

(d) There are 21 items under ASR control at the end of the quarter, an increase of seven items over the last quarter. The items under ASR control are:

CONFIDENTIAL

CONFIDENTIAL

AVFA-GC-01 15 May 1969
SUBJECT: Operational Report of Headquarters, I FFORCEV for Quarterly
Period Ending 30 April 1969 RCS CSFOR-65 (R1) (U)

<u>DODIC</u>	<u>ITEM</u>
B568	40mm HE
C226	81mm ILLUM
C256	81mm HE
C445	105mm HE
C705	4.2 HE
C706	4.2 ILLUM
D544	155mm HE
D572	175mm HE
D680	8" HE
G911	Gren Hd Offensive
H490	2.75 LT PD
H534	2.75 HV PD
H459	2.75 Flechette
L312	Sig Illu WSP
M032	TNT, 1lb Block
M131	Cap, Blasting
M456	Cord, Detonating
B567	Ctg, 40mm CS
F674	FX Burster
K935/967	Thickner M4
F497	Cannister, Cluster E158

(2) Services: During the reporting period, the I FFORCEV CMMI team conducted 13 inspections. Eleven units were rated satisfactory and two units were rated unsatisfactory. In the area of Materiel, the lowest scores have been obtained in tactical and support vehicles and special purpose equipment-engineer. Maintenance Management and Operations contributed to both unsatisfactoriness; however, units are continuing to improve in this area due to the development of maintenance SOP's and added command emphasis.

CONFIDENTIAL

CONFIDENTIAL

AVFA-GC-OT

15 May 1969

SUBJECT: Operational Report of Headquarters, I FFORCEV for Quarterly
Period Ending 30 April 1969 RCS CSFOR-65 (R1) (U)

(3) Transportation

(a) Air:

1. The volume of airlift operation throughout II CTZ has shown a decreasing trend during the current quarter. Air movement of routine cargo from Cam Ranh Bay Depot to forward areas has shown a decrease as increased emphasis is being placed on highway movement. Qui Nhon Depot made no routine shipments to forward areas.

Supply Movements from Depots to Forward areas.

	<u>Air (S/T)</u>	<u>Sea (S/T)</u>	<u>Hwy (S/T)</u>	<u>Total (S/T)</u>
Feb	1,590	4,645	20,871	27,106
Mar	442	1,895	24,907	27,244
Apr	<u>429</u>	<u>3,715</u>	<u>20,851</u>	<u>24,995</u>
Total	2,461	10,255	66,629	79,345

2. The decreasing trend in emergency airlift noted during last quarter has reversed itself during this quarter with eight emergency airlift missions (36 sorties) being flown during February, 12 missions (45 sorties) during March and 14 emergency airlift missions (58 sorties) during the month of April. This increasing trend parallels the increase in enemy activity throughout II CTZ.

Emergency Airlift (1968-1969):

	<u>C-130*</u>	<u>C-123*</u>	<u>C-7A*</u>	<u>Pax</u>	<u>S/T Cargo</u>
May-Jul	685	49	0	13,569	7,600
Aug-Oct	186	72	42	5,011	2,079
Nov-Jan	54	1	32	3,199	252
Feb-Apr	92	34	5	6,736	1,309

*=Sorties

3. I FFORCEV-dedicated C-7A aircraft movements remained at a relatively constant level.

Dedicated C-7A Airlift (1968-1969):

	<u>Sorties</u>	<u>Pax</u>	<u>S/T Cargo</u>
May-Jul	5,765	42,005	2,725
Aug-Oct	6,321	50,144	3,255
Nov-Jan	6,108	45,984	2,938
Feb-Apr	6,100	41,502	3,019

CONFIDENTIAL

AVFA-GC-OT

15 May 1969

SUBJECT: Operational Report of Headquarters, I FFORCEV for Quarterly Period Ending 30 April 1969 RGS CSFOR-65 (RI) (U)

(b) Highway: The major highways in II CTZ remained open throughout this quarter, with high volume of convoy traffic noted. An increase of ambush incidents during March (35 versus average of 15 per month) on QL 19 did not significantly hinder convoy operations. No US resupply convoys are currently being conducted to Cao Khe. Joint US/ARVN convoys were being conducted to Phan Thiet, one each during the last three months.

(c) Water: The only forward area being supplied by water in II CTZ is Phan Thiet. This operation is constantly hindered by shifting sandbars and changing tides. The B.D.L. Page is conducting a roll-on roll-off shuttle between Cam Ranh Bay and Phan Thiet.

(d) Rail: The opening of the railroad to military cargo in much of southern coastal II Corps in October 68 led to an expanded rail movement capability. The bulk of the tonnage is still being shipped from Qui Nhon. Rail movements from Cam Ranh Bay to Phan Thiet are still not possible pending completion of repair work to right of way and bridges.

Rail Movements (Feb-Apr 69):

	<u>From CRB</u>	<u>From QNH</u>	<u>Total S/T</u>
Feb	651	6,017	6,668
Mar	409	6,769	7,178
Apr	<u>538</u>	<u>6,674</u>	<u>7,212</u>
Total	1,598	19,460	21,058

e. (C) Civil Operations and Revolutionary Development Support (CORDS).

(1) Office of Development Operations.

(a) Agriculture.

1. GVN has given II CTZ a quota of 27,000 hectares for IR-8/5 rice plantings for CY 1969. Province GVN Service Chiefs have pledged 21,000 hectares. TN-8 rice will be a source of seed for planting. Insects have not seriously affected the rice crop except for Phu Yen Province where Gall Midge was reported. However, the rice crop was ready to harvest and an estimated 100 hectares of TN-8 rice fields were affected by a 10% loss.

2. Rice training for cadre is being conducted in all major rice areas. The new slide sets are a great assistance to the extension training program.

3. On 5 Mar, the Director General of Agriculture conducted a regional rice meeting in Nha Trang. Representatives of USAID AR/RD Saigon attended. The Regional Agricultural Staff, Provincial Advisors and GVN Agricultural Chiefs represented II CTZ.

4. Shipments of both Urea and Ammophosho (20-20-15) were shipped to Nha Trang and the highland provinces after TET. These shipments have caused a drop in selling price from 1000 piasters to 800 piasters per 50 kilo bag.

CONFIDENTIAL

CONFIDENTIAL

AVFA-GC-OT

15 May 1969

SUBJECT: Operational Report of Headquarters, I FFORCEV for Quarterly Period Ending 30 April 1969 RCS CSFOR-65 (R1) (U)

5. A problem exists on the North Main Canal, Phu Yen Province due to mortar damage to a concrete flume. This cannot be repaired until the water is shut off in December 1969. The Nippon Koei Co continued an irrigation survey in Binh Dinh Province. Construction of An Thuan Dam in Binh Dinh Province has commenced. A contract has been signed to make the necessary repairs on the upper part of the Phan Rang Irrigation System.

6. A continued increase in vegetable production and a 30% to 40% decline in prices was noted. Much of this production is to meet increased local demand by US military bases. A considerable interest in fruit tree planting particularly in the highlands was noted. Several nurseries have been started.

7. The vaccine program is operating satisfactorily with adequate materials received and distributed.

(b) Education.

1. On 24-25 Mar in Qui Nhon, the elementary education chiefs in Region II held their final conference of this school year. The Education Advisors representatives from Saigon and regional headquarters participated in the meeting.

2. On 21-25 Apr in Phan Rang, the first workshop on adult literacy was held with 39 Vietnamese and eight Cham from various RD Cadre groups in attendance. These workshops are the result of agreements by USAID and GVN to support and encourage the alleviation of illiteracy in the countryside. Instruction was provided by the provisional education office.

3. On 3-10 Feb 69, nine participants from II CTZ attended a Physics Chemistry Workshop for First Cycle Secondary Education Teachers in Saigon. This was the first in-service training workshop for secondary teachers conducted under the USAID sponsored project.

4. Two secondary schools in Khanh Hoa Province and one secondary school in Dalat have been allocated commodities for construction of a total of 22 classrooms. A new agricultural high school in Buon Son District, Ninh Thuan Province started classes 3 Feb with 103 students.

5. Current elementary school enrollment figures in II CTZ are 305,259 as compared to 265,000 in 1968. Most of the 1968 school construction has been finished.

(c) Refugee Division.

1. As the pacification emphasis was shifted to the coastal provinces, the focus of attention on the refugee return-to-hamlet program was also shifted to the coastal provinces. During April 1969, 916 refugees were returned to their original hamlet of Dien Tho, Dien Khanh District, Khanh Hoa Province. Approximately 800 refugees moved back to their original hamlet 15 km NE of their refugee site at Binh Hoa, Binh Thuan Province. Small return-to-hamlet movements took place in Phu Yen.

CONFIDENTIAL

CONFIDENTIAL

AVFA-CC-OT

15 May 1969

SUBJECT: Operational Report of Headquarters, 1 FFOACGV for Quarterly Period Ending 30 April 1969 RCS CSFOA-65 (R1) (U)

2. Approximately 13,000 refugees were resettled in place in Kontum, Lam Dong, Tuyen Duc, and Phu Bon Provinces in February and March 1969. Fighting in Kontum produced 5,000 refugees while a reconsolidation of Montagnards in Tuyen Duc produced 2,302 refugees. During the period, a general reduction in the numbers of refugees generated and a considerable increase in refugees resettle was noted.

(d) Self Help.

1. As of 31 Mar 69, 2241 of the 1968 Self Help Projects are completed and 852 are still underway.

2. The Self Help program for 1969 involves different findings, planning and implementing procedures, Training officials in the concept and mechanics of the new system is being conducted.

(3) Logistics.

1. Construction of maintenance shops is proceeding slowly because of a shortage of funds and construction material at province level. Difficulties in recruiting GVN personnel to staff completed shops has been overcome by utilization of Hoi Chanh personnel.

2. As of 30 Apr 69, six shops of the 13 shops programmed for II CTZ were open and conducting training. Two others are partially staffed and training personnel on a limited basis.

(f) Public Health.

1. During the period, the primary emphasis was on the National Plague Control Program and auxiliary activities. Combined efforts of the Public Health Division, ROKA and GVN health workers has been successful in Binh Dinh, Khanh Hoa, Cam Ranh and Ninh Thuan Provinces where the incidence of plague has been more extensive in recent years. By the end of March, 56,564 of 74,643 houses in these provinces had been dusted.

2. Three Impact Hospitals in Bong Son, Binh Dinh Province, Lam Dong Province, and Phu Bon Province were officially opened and operational. On 2 Apr, Khanh Hoa Province School of Nursing was opened admitting 37 students. Ban Me Thuot Assistant Nurse School began its second class with 49 Montagnard students. The Evangelical Assistant Nurse School, a private school in Nha Trang recognized by the Ministry of Health, graduated 8 students on 12 Mar 69. The next class began on 17 Mar with 105 students.

3. In Feb, a 200 Bed Surgical Hospital Equipment Set donated by the Canadian Government was issued to the Medical Sub-Depot, Nha Trang. It is to be used in part or in its entirety to replace equipment damaged at any Ministry of health hospital. At the end of March, all members of an original 13 man team of Korean Medical Supply Specialists were relieved from duty at the depot. Their mission was to train Vietnamese in the operation of the depot.

CONFIDENTIAL

CONFIDENTIAL

AVFA-CC-CT

15 May 1969

SUBJECT: Operational Report of Headquarters, I FFORCEV for quarterly
Period Ending 30 April 1969 RCS CSFOR-65 (R1) (U)

(2) Office of Territorial Forces

(a) Regional and Popular Forces

1. Since 1 February 1969, many significant improvements in the areas of training, advisory effort, equipment and force structure have occurred.

2. While there was no change in the number of authorized RF companies or PF platoons in II Corps during the quarter, 31 additional RF companies were recruited and organized. Of the 355 RF companies and 1203 PF platoons presently authorized, 342 RF and 1203 PF units are on hand. Three CIDG camps, Tan Rai in Lam Dong Province, Cung Son in Phu Yen Province, and Ha Tay in Binh Dinh Province converted to RF on 31 Mar 69. Eleven RF companies were formed from these conversions. An unusual alteration in RF force structure took place this quarter when 485 ex-Fulro Montagnards in Ban Me Thout were formed into five RF companies. These companies are presently undergoing basic training at Lam Son Training Center. Upon completion, four companies will be deployed in Lam Dong, Darlac, Kontum, and Quang Duc Provinces. The remaining company will be deployed in Darlac Province to replace a RF company there which is at a low strength because of limited recruiting capabilities.

3. During March, 10 additional RF/PF Group Headquarters were authorized for II Corps. Six were requested to increase the span of control of provinces involved in CIDG conversion. The remaining four will provide control of companies authorized for CY 69. This increase in authorization brought the number of RF/PF Group Headquarters to 54 of which all are presently operational.

4. Phase I of the initial distribution of the M-16s to RF and PF units ended in April. One hundred and twenty-six RF companies and 321 PF platoons have received 11,714 and 10,403 M-16s respectively. There has been a total of 23,002 M-16s distributed to RF/PF units throughout II Corps. Eight hundred and eighty-five of these weapons have been issued to training centers, intelligence units and Administration and Direct Support Logistics Companies (A&DSL).

5. There has been no additional authorization of Mobile Advisory Teams (MAT) within II Corps, however, a MAT in Darlac Province was transferred to Kontum Province where there is a greater need for advisory assistance. The majority of MAT personnel have been conducting M-16 familiarization training, emphasizing care and cleaning, assembly and disassembly, marksmanship and safety.

6. During the period, there have been no newly initiated schools for RF/PF leaders, however, 197 RF officers and 793 RF and PF NCO's have graduated from the 4th Inf Div, Task Force South and 173d Atn Bde leadership schools. The Medium Range Reconnaissance Patrol Training Course has graduated 715 RF officers. The 22d ARVN Div sponsored leadership school has graduated 25 RF officers.

7. The issuance of all authorized 57mm RR to RF weapons platoons was completed during this period. Twenty-three of the authorized 61mm mortars for the weapons platoons are presently on hand. The additional fire power provided by these weapons should enable RF/PF units to conduct more aggressive small unit operations.

CONFIDENTIAL

CONFIDENTIAL

AVFA-GC-OT

15 May 1969

SUBJECT: Operational Report of Headquarters, I FFORCEV for Quarterly
Period Ending 30 April 1969 RCS CSFOR-65 (R1) (U)

(b) National Police Operations

1. National Police activity and deployment continued to show an increasing awareness in all provinces for the necessity of prompt and thorough implementation of National Police and Ministry of Interior directives. Inherent in this is centralized control of police affairs at national level and a lessening of Province Chief's influence. In accordance with the 1969 Pacification Program, 50% of the Uniform National Police force will be assigned to district and lower levels. Currently, 41% are so assigned.

2. An increase in traffic accidents and fatalities throughout II CTZ has led to increased efforts in conjunction with traffic safety programs. Traffic education classes are being conducted throughout II CTZ. 20,000 traffic safety booklets have been distributed, traffic laws are being more stringently enforced, and greater use is being made of traffic control devices such as regulatory signs, center lines and cross walks on the roads. Joint mobile patrols consisting of US MP's, National Police, and FWF Military Policemen have been established as appropriate. There are 86 mobile patrols operating in II CTZ, 48 of which are combined patrols. A combined police operation center has been established in Qui Nhon City, Binh Dinh Province.

3. Arrests of VC/VCI and other categories of apprehension have increased due to the dispersion of National Police to district-level assignments. The availability of and cooperation with territorial and regular forces in cordon and search operations has been a contributing factor in the noteworthy successes of police in Binh Dinh, Binh Thuan, and Darlac Provinces. There are 27 DIOCC's, 9 PIOCC's, and 2 CIOCC's with an assigned platoon size National Police Field Force action arm.

4. Resource Control checkpoints in II CTZ have achieved excellent results. They permit the relatively free flow of commercial traffic and general populace while inhibiting the movement of enemy supplies, contraband and black market goods. A Resources Control Council has been formed in Binh Thuan Province for the disposition of confiscated commodities.

5. An emerging marine police capability in Cam Ranh and other coastal areas shows promise of increasing importance in the enforcement of customs regulations and collection of export taxes. At present, 98 Marine Police are assigned to Cam Ranh.

6. The National Identification Card Program commenced in II CTZ on 2 Dec 68. As of 30 Apr 69, approximately 160,000 persons have been registered.

7. Combined Telecom Directorate is providing logistical support and maintenance for all National Police radios in II CTZ. FSD Telecom Officer has also been assigned responsibility for monitoring the Village/Hamlet Radio System (VHRS). VHRS will ultimately involve more than 4,000 radios which are being distributed in accordance with the priorities established for national distribution. Khanh Hoa Province has received radios under this program with the remaining provinces to receive radios as their priority comes up. All provinces but Lam Dong and Quang Duc have a US-NGO assigned to work with the VHRS. Khanh Hoa and Binh Dinh also have a TCN working directly with the program providing technical maintenance support.

CONFIDENTIAL

CONFIDENTIAL

AVFA-GC-OT

15 May 1969

SUBJECT: Operational Report of Headquarters, I FFORCEV for Quarterly Period Ending 30 April 1969 RCS CSFOR-65 (R1) (U)

8. Prisons, detention facilities and jails in II CTZ have increased in capacity by approximately 600 spaces during this quarter. An An Tuc Detention Center has been completed with 1,500 spaces now available. The total inmate population in II CTZ Centers is 400 less than it was 31 Jan 69, due in part to the extraction of several hundred prisoners from mainland facilities to Con Son Island. Screening and Detention Centers will be constructed in each province, providing additional capability to Police Special Branch in the eradication of VC Infrastructure.

(c) Self-Defense Division

1. The Peoples Self Defense Force program continues to progress in the II CTZ despite the mounting VC attacks directed at its members and organized villages and hamlets. The record reflects numerous accounts of incidents and casualties sustained during the past quarter which is prima facie evidence of their willingness to participate, even under adverse conditions, in the National Defense effort. In spite of skepticism of local officials and other inhibiting factors, the PSDF is developing into a viable force and appears destined to make a significant contribution to the overall pacification effort.

2. Total membership in the II CTZ now stands at 173,695 organized, 117,351 trained and 44,966 armed. Substantial increases were realized during the past quarter. However, in terms of numbers recruited, trained and armed, accomplishments remain below desired levels required to attain mid-year goals. Statistics quoted above represent 52%, 44% and 59% of the respective organized, trained and armed 1969 goals. During the period, 21,746 members were organized, 16,290 were trained and 15,634 were armed, representing 14%, 16% and 53% respective increases over previous aggregate accomplishments. The large increase in weapons issued to the PSDF is a direct result of intense pressure placed on Province Chiefs and District Chiefs to distribute available arms to organized PSDF groups.

3. A cursory inspection was conducted at the province level by the PSDF Senior Advisor and his Vietnamese counterpart in the 12 provinces and two autonomous cities during the quarter. The review of the forces showed evidence of sincere dedication, enthusiasm and high esprit among the people. The II Corps staff sections and US advisory personnel at all echelons appear to be aggressively attacking the problems of recruitment and arming; however, training programs appear to be deficient. All indications point to a critical need for more definitive guidance and standardization in the training program. Inspection tours are programmed during May, June and July to review PSDF organization and operations at the village and hamlet level.

4. There were four significant developments in the program during the quarter which should add impetus and depth to future evaluations and assessments.

a. Increased US advisory assistance and influence - PSA's have recognized the PSDF program as a productive vehicle for pacification and have given the program their personal attention. Most provinces

CONFIDENTIAL

CONFIDENTIAL

AVFA-GC-07

15 May 1969

SUBJECT: Operational Report of Headquarters, I PFC(CEV for Quarterly
Period Ending 30 April 1969 RCS CSFOR-65 (R1) (U)

have assigned advisors who devote at least 50% of their time to the program and work with full-time ARVN advisors at province level. II Corps ARVN staffs are now operational at province and district levels assisting establish civilian committees. MATs Teams have taken a more active role in training and report encouraging results.

b. PSDF Cadre - Approval and establishment of a paid PSDF Cadre consisting of five members at province level and three members at each district was authorized by the MOI during the quarter. The first group of 50 members from the II CTZ received specialized training at the Vung Tau National Training Center during the period 7 Apr through 5 May.

c. Basic loads and training, ammunition - Basic loads and training ammunition allocations were published by the MOI during the quarter, alleviating one of the major logistical problems. A&DSL's are processing requests with minimum delay thus facilitating the training and arming facets of the program.

d. Training - The MOI has published a 60 hour POI for immediate implementation Corps wide. The program consists of training in military subjects, politics and specialized areas; e.g. First Aid, Supply and Relief, and Intelligence. This brief but comprehensive program provides a firm base for members to effectively perform their mission without imposing too heavily on their time.

5. The revision of reporting procedures and the automatic data processing of PSDF statistics should provide the basis for future in-depth assessment and evaluation of the program.

(3) Office of PSYOP, Chieu Hoi and Civic Action

(a) Civic Action:

1. The enemy's post TET offensive had a limited effect on civic action performed through self-help by the populace. Prior to, and during TET, many projects that were under way experienced a slow down. As soon as TET was over, and no substantial enemy action had developed, the populace again eagerly participated in self-help projects, displaying more enthusiasm than before.

2. ARVN units are increasing their efforts in civic action participation. During the past quarter, a pilot project was initiated in which US units and ARVN would pair-off and work together to initiate and complete civic action projects. In Lam Dong Province, a well was dug, pump installed and storage reservoir constructed to provide water for a Montagnard hamlet. This project was accomplished through the joint efforts of the 3d Bn, 503d Abn Inf, 173d Abn Bde, Task Force South and the 53d ARVN Regt. A school construction project is currently under construction in Vo Lan, Kontum Province, under the joint efforts of the 2d Bde, 4th Inf Div, and the 3d Bn, 42d ARVN Regt. Projects such as these have a favorable impact on the local populace and contribute a great deal to the overall pacification effort.

3. In addition to ARVN projects are the civic action projects initiated by Popular Force units which have been on the increase

CONFIDENTIAL

CONFIDENTIAL

AVFA-CC-OP

15 May 1969

SUBJECT: Operational Report of Headquarters, I FFORCEV for Quarterly Period Ending 30 April 1969 RCS CSFOR-65 (R1) (U)

during the past few months. Current projects are the maintenance of public buildings and grounds throughout II CTZ and extensive clean-up campaigns in and around their villages and hamlets. MEDCAPS are also being performed by PF units. These civic action efforts are appreciated by the people and assist in creating a favorable image of the GVN.

4. Civic action projects that have a high impact upon the people are capitalized upon at every available opportunity. A prime example of this has been the rebuilding of villages and houses destroyed by enemy actions in Kontum Province. In these particular instances, civic action personnel were on the scene immediately, and construction was started upon their arrival. Other CORDS agencies became involved and food and other commodities were distributed. Within a short period of time, these villages and families were back at their normal routine.

5. Civic action aims were slanted at new horizons during the past quarter. During the month of April, over 1600 youths were transported to an outing on Binh Ba Island, Cam Ranh, for a jamboree and entertainment. This was accomplished through the joint coordination and efforts of Youth Affairs and Civic Action personnel. Other successful youth jamborees were conducted in other II CTZ cities. The attention given to these youths should provide for large dividends in the future.

6. A plan for the 3d Bn, 503d Abn Inf, 173d Abn Bde OPCON to Task Force South, to place squad size elements in selected hamlets in Lam Dong Province has been initiated. These squads will render assistance in the training and re-inforcing of the local Popular Forces. The most substantial benefits to be gained from this will be the conduct of civic action projects at the grass roots level.

7. The Pacification Imprest Fund (AIF) expenditures during the 1st quarter CY 69 have been primarily for materials, labor, equipment, and construction in support of public works, education, psyops, and health programs. Currently, II CTZ has utilized 10% of the funds allocated during 1st quarters CY 69 (31,500,000 \$VN). Continued extensive use of the fund is expected, though expenditures will fluctuate in proportion to the military, political, economic and social efforts in the various program areas.

8. A health school for health workers in the Peoples Self Defense Force has been in constant operation by the 173d Abn Bde at LZ English. The course is four weeks in duration and has 20 students in each class. The fifth class graduated on 7 Apr 69. Instruction is provided jointly by US and ARVN personnel. Upon graduation, students receive a certificate and return to their hamlet where they assist and serve as local health workers.

9. The most significant accomplishment within MCAD has been the success obtained in civic action coordination at all levels in II CTZ. Civic action in II CTZ is now coordinated through all channels to include US units and at village, hamlet, district, and province level. A good example of this coordination is in Ninh Thuan Province where a joint US, GVN and Australian civic action hamlet projects is underway.

CONFIDENTIAL

CONFIDENTIAL

AVFA-GC-GT

SUBJECT: Operational Report of Headquarters, I FFORCEV for Quarterly Period Ending 30 April 1969 RCS CSFOR-65 (R1) (U)

(b) Military PSYOP

1. Military PSYOP activities continued at a high level during the quarter. The 8th PSYOP Bn printed 38,193,000 leaflets and 759,000 newspapers. Aerial operations included the dissemination of 597,088,000 leaflets and 2316 loudspeakers hours.

2. Major PSYOP campaigns conducted during the quarter were GVN Third Party Awards Program and the TET Campaign. More than 12,000,000 leaflets, handbills, and posters have been disseminated in support of the Third Party program. Maximum emphasis was given to hand to hand distribution of PSYOP materials and face-to-face communication. One-hundred-forty-four million leaflets, handbills and posters were disseminated in support of the TET Campaign. The campaign was divided into three phases; Pre-TET, TET, and Post TET. TET related PSYOP media in support of the Chieu Hoi Program was fused into the regular PSYOP activity reaching a peak during the TET phase. A gradual tapering off of TET related PSYOP media was effected during the Post TET phase utilizing themes to exploit those VC members who were able to return to their families for the holidays. Appeals were made for them to remain with their families and to rally to the GVN.

3. The expanded version of the organization for PSYOP in II Ciz was implemented during the quarter. The building facility for the Regional PSYOP Coordinating Center (RPCC), Nha Trang was completed and dedicated during the month of February. The results of the operation of the RPCC, after two months, have been encouraging. The presence of PSYOP trained Vietnamese military and civilian personnel within the RPCC has been a major contributing factor to the overall improvement in the quality of propaganda produced. A system of free and mutual constructive criticism has enabled all three forces, ARVN, ROK and US, to make innovations in their approach to PSYOP. All provinces have established PSYOP Coordinating Committees with meetings scheduled, at a minimum, of one per month. Nine Province PSYOP Coordinating Centers are now established and functioning. The remaining provinces are making satisfactory progress toward establishment of their PSYOP Coordinating Centers. The first meeting of the Regional PSYOP Coordinating Committee was conducted at Pleiku during the month of April with the Commanding Generals ARVN II Corps, ROKV-FC and I FFORCEV in attendance. In addition, representatives from the entire II Corps PSYOP community were present for the meeting. Highlights of the meeting included presentations from all three nations concerning PSYOP operations and lessons learned during the quarter.

4. The 8th PSYOP Bn has made a big effort to improve its capability to produce PSYOP media in Montagnard dialects. B Co has developed the capability to produce material in four dialects; Rhade, Jarai, Bahnar and Mnong. Lam Dong Province has the capability of writing PSYOP material in the Koho dialect. Sample of a poster in Koho is shown at incl 8. Instructions have been dispatched to all HE Field Teams, directing Montagnard interpreters be used as face-to-face communicators in operations where Montagnards are the significant audience. PSYOP media dissemination in Montagnard languages has shown an increase during

CONFIDENTIAL

CONFIDENTIAL

AVFA-GC-OT

15 May 1969

SUBJECT: Operational Report of Headquarters, I FFORCEV for Quarterly
Period Ending 30 April 1969 RCS CSFOR-65 (R1) (U)

the quarter. This was highlighted by operations conducted in Lam Dong and Binh Thuan Provinces. The Lam Dong operation consisted of serial broadcasts and leaflet dissemination in the Koho dialect. Aerial broadcasts in Rhade were used to support the Binh Thuan operation. These two operations resulted in the resettlement of more than 200 Montagnards and resulted in 34 Hoi Chanh. Interrogation of the Hoi Chanh revealed that the broadcasts and leaflets in their respective Montagnard dialects were the only type of PSYOP material that could be understood and consequently believed.

5. A realignment of PSYOP assets was accomplished during the period with emphasis on employment of HE Teams. LOIs were dispatched directing that HE Teams be placed OPCON to the Province Advisory Teams with the proviso that tactical units be provided HE Team support as required. HE Team operations, under provincial control, are more effective since they are best used in pacification and revolutionary development PSYOP missions. Additionally, the HE Team is able to gain intimate knowledge of the PSYOP situation in a particular province and is in a better position to advise and assist ARVN and GVN PSYOP organizations.

6. Increased emphasis was placed on production of localized PSYOP media to exploit specific situations during the quarter. LOIs were dispatched with specific instructions and guidance for production of personalized PSYOP media directed at specific individuals, units, hamlets etc. Copy of personalized PSYOP leaflet is shown at Incl 9.

7. The procedure for obtaining quick reaction PSYOP aircraft support, initiated during last quarter, has been fully implemented during the period. The system involves a PSYOP aircraft contacting each province via radio daily to obtain the locations of targets that might be available.

8. All O2B PSYOP aircraft were equipped with Early Word capabilities during the reporting period. Early Word is the nickname given to a device used in PSYOP aircraft which allows a signal transmitted from a ground station via radio to be connected to a loudspeaker system in the aircraft and be re-broadcast to the ground. The process was tried for the first time in II Corps in Binh Thuan Province. The signal broadcasted through the speaker system was of better quality and louder than the signal produced by tape recording.

(c) Psychological Operations (Civilian)

1. A test program, in which Blue Eagle airborne radio programs are broadcast three hours a day, have helped to get radio reception over a broad section of the highlands, where until recently, Radio Hanoi and the VC radio dominated the air waves. A fair share of the 210 MEC radios provided by JUSPAO during the recent APC effort have been placed in APC-targeted hamlets in the highlands.

2. By the end of April most, if not all, of the deadlined audiovisual equipment in the hands of APA's and VIS personnel in II CTZ had been either replaced or repaired, following survey made by a joint MDI-JUSPAO team sent out from Saigon.

CONFIDENTIAL

CONFIDENTIAL

AVFA-GC-OT

15 May 1969

SUBJECT: Operational Report of Headquarters, I FFORCEV for Quarterly
Period Ending 30 April 1969 RCS CSFOR-65 (RL) (U)

2. Although the APC program came to an "official" close at the end of January, APA's/PSYOP in cooperation with VIS continued to encourage the further building of VIS cadre representation in APC hamlets. As additional radio and TV sets were provided by JUSPAO, these were set in place. Also, APA's/PSYOP continued to lend both advise and material support in the construction of bulletin boards put in place in the APC hamlets, and encouraged VIS personnel to get provincial and district news sheets down to these hamlets.

(d) Chieu Hoi

1. Chieu Hoi Rate: The 882 Hoi Chanh who rallied during February, March, and April is approximately two and one half times the 314 who rallied during the corresponding period in 1968. In February 141 enemy rallied, in March 428 rallied, and in April 313 rallied. March was the highest month since June 1967. The two general reasons for this marked increase are the enemy's post-Tet offensive, which brought more friendly pressure to bear and which offered more enemy a better opportunity to rally, and the Xuan Que Huong campaign, which is the three-month Vietnamese spring campaign that began just before Tet.

2. Armed Propaganda Teams (APTs): The number of APTs increased slightly from 720 to 735. During March, the Chieu Hoi Ministry issued APT equipment and material to be tailored into uniforms. The Defense Ministry said that better weapons for the APTs will not be available until September 1969.

3. Facilities: The Chieu Hoi Service completed 16 district centers, and the Chieu Hoi Ministry transferred the funds for the remaining 16 from 1968 to 1969 budget. Darlac completed its APT house and the Reconstruction Ministry, after nearly a year's delay, approved the technical dossier for the new Chieu Hoi Center in Binh Thuan. Construction of the new center in Phu Yen began. In Darlac, a dispute about the ownership of the land where the second hamlet was to be located delayed its construction, and lack of cement in Phu Yen delayed the construction of its third hamlet. To improve security, PSD installed ten two-way radios in selected Chieu Hoi centers and hamlets.

4. Training, Exploitation, and Follow-up

a. Political training continued to be haphazard.

b. Vocational training nearly stopped during the Tet period and has not since recommenced in most provinces.

c. The most noteworthy intelligence and tactical exploitation of a Hoi Chanh occurred in the 24th STZ where a Hoi Chanh led military units on operations which entitled him to a reward of 2,000,000 piasters.

d. Follow-up contacts increased about 50% over the previous quarter, but no province's program is well-enough organized to allow the codification of data about ex-Hoi Chanh.

CONFIDENTIAL

CONFIDENTIAL

AVFA-GC-OT

15 May 1969

SUBJECT: Operational Report of Headquarters, I FFORCEV for Quarterly
Period Ending 30 April 1969 RCS CSFOR-65 (R1) (U)

(4) Revolutionary Development Cadre Operation

(a) Revolutionary Development Cadre.

1. Of 380 RD Cadre Groups authorized for II CTZ, there were 371 active groups in the field. Average strength of RD groups was 27 Cadre. As a result of a nationwide curtailment, all recruiting of RD Cadre in II Corps ceased as of 9 Mar. A weakening in the physical security of RD groups caused by decreasing the size of the groups to 30 men, and a general failure on the part of Province Chiefs to provide RF/PF support to groups deployed under the 1969 Pacification and Development Plan has brought about an increase in Cadre attrition. The impact of attrition is greatly magnified in the face of the recruiting curtailment which prevents replacement of losses. Binh Dinh Province was forced to disband four groups, all of which were below minimum strength, in order to acquire filler personnel for groups operating in critical pacification areas. Binh Thuan, Khanh Hoa, Ninh Thuan, Phu Yen and Pleiku Provinces have yet to activate one or more cadre groups authorized under the 1969 plan due to personnel shortages.

2. Son Thon (formerly Truong Son) Revolutionary Development (STRD) Cadre authorizations were reduced to 84 groups, with Quang Duc Province absorbing the loss. Two understrength STRD groups were disbanded in Quang Duc. Spaces for one group were reallocated to Pleiku Province, while the remaining spaces were given to another corps area. Personnel made excess by the disbandment in Quang Duc Province were used as fillers for other groups or were reemployed by other GVN services. Average strength of STRD groups at the end of the quarter was 65.

3. Control of cadre activities was decentralized during the quarter in favor of the village concept. Many village chiefs know little about the RD program and were generally not prepared to undertake responsibility for supervising the RD Cadre assigned to their village. Special training courses were established at Vung Tau National Training Center for village and hamlet officials and administrators. Although the number of persons attending the courses from each province is relatively small, the program will help to minimize this problem.

4. In Darlac Province, STRD groups assigned to Buon Ho Cu resettlement area assisted the people in recovering their personal belongings which they had been forced to leave behind in Buon Gier and Buon Crieng villages. They were assisted by an Engineer Company and an armored element of the 4th Inf Div. Over 100 tons of rice and household items were recovered.

5. In February and March, RD groups in all provinces assisted in organizing and conducting village and hamlet elections and forming village and hamlet councils. In several provinces, RL cadre were entered on ballots as bonafide candidates for office, and several were elected. Participation in elections by cadre has local and national sanction though not written out as such.

6. Although there has been an increase in the number of reported contacts between RD/SRD groups and the VC, there is nothing to indicate that greater emphasis is being placed on the elimination of cadre by

CONFIDENTIAL

CONFIDENTIAL

AVFA-GC-OT

15 May 1969

SUBJECT: Operational Report of Headquarters, I PFORCEV for quarterly
Period Ending 30 April 1969 RCS CSFOR-65 (R1) (U)

the enemy. Due to the split of cadre groups, almost twice as many hamlets are occupied by the groups, thereby offering more targets for the VC. Additionally, there has been a significant increase in the number of contacts which have been initiated by RD/STRD against the VC. The cadre are relying more heavily on the mobile defense technique and as a consequence are picking up the movement of the enemy before he gets a chance to enter a hamlet.

(b) PHUNG HOANG. The PHUNG HOANG program made encouraging progress during the reporting period. VCI neutralizations should approximate 900. This is not only a quantitative improvement over the preceding period, but more important, also a qualitative improvement with more hard core VCI being neutralized than ever before. This is particularly significant in view of the new and notably more stringent VCI identification criteria effected 1 Feb 69. In addition, 324 VC/NVA soldiers, 3 guerrillas, and 1255 VC support personnel were neutralized as a result of PHUNG HOANG operations in February and March. While not VCI, this 2042 total in conjunction with VCI neutralizations, does provide a more complete picture of the impact PHUNG HOANG operations are having on the enemy. A major effort was initiated during the period to improve the organizational and operational effectiveness of existing PHUNG HOANG permanent Centers, especially in priority areas. A standardized P/DIOCC Inspection/Evaluation Plan was prepared as a managerial tool for this purpose. An initial evaluation of all centers was made in February and subsequent evaluations are made monthly based on new data, and appropriate upgrading or downgrading is effected and guidance and advice given. Six DIOCCs were upgraded to the operational and effective category during the period. Currently, three P/OCCs and 12 DIOCCs are rated as open but not operational, five P/DIOCCs and 23 DIOCCs are operational but not effective, and five P/OCCs and 16 DIOCCs as operational and effective. The program continues to achieve its greatest success where GVN district and province officials understand and support the effort; an adequate reaction capability exists, and the advisory effort is geared to local level solution of problems in close coordination with Vietnamese counterparts. Perhaps the most significant event during the period was the organization of a mobile training team and the preparation of a PHUNG HOANG briefing to be presented to all II Corps ARVN tactical units by the Corps PHUNG HOANG Permanent Office. US unit support of PHUNG HOANG improved significantly during the three month period. The establishment of VCI branches in the G2/S2 offices of major I PFORCEV tactical units is especially noteworthy. Improvement in ROKA coordination and support of PHUNG HOANG was also readily evident.

(5) Office of Management Support

(a) Communications. In mid February, an emergency power source was established in the CORDS II CTZ Headquarters communications office. Prior to this time, batteries, charged by the AC primary power source, were utilized to maintain operation of CORDS radio equipment during an AC power failure. This alternate power source only provided approximately three to four hours of power for the radios while teletypes and key system telephones were rendered inoperative. With the installation of a 1.5 kw portable generator, there is sufficient power to maintain all three of these necessary communications systems during emergency situations.

CONFIDENTIAL

CONFIDENTIAL

AVFA-CC-01

15 May 1969

SUBJECT: Operational Report of Headquarters, I FFORCEV for Quarterly Period Ending 30 April 1969 RCS CSFOR-65 (R1) (U)

f. (C) Personnel and Administration.

(1) Roster of Headquarters I FFORCEV key personnel is at Incl 10.

(2) Personnel strengths of assigned, attached and OPCON units are at Incl 11.

(3) Military Personnel Management: During the reporting period, the enlisted and officer strength of I FFORCEV units improved and is currently satisfactory, although some grade and MOS imbalances still exist, especially in the E-5 and E-6 NCO positions for Artillery. USARV continued to infuse the 4th Bn, 60th Arty with MOS 11E personnel from the replacement stream. Two other units showed minor rotational humps and are being infused through increased replacement input. Lack of timely receipt of assignment instructions for rotating personnel continues to be a problem. Letters were forwarded to USARV on this subject. Two new units were added during the reporting period, the 1st Chem Det and 32d Chap Det. The authorized strength of the 41st and 52d Arty Group headquarters increased from 90 to 109 enlisted personnel.

(4) Awards and Decorations: During the past quarter, to insure that recommendations for award of the Legion of Merit were given special consideration, a separate board consisting of Colonels was established to evaluate such recommendations. An Air Medal study was conducted to determine if all II Corps units were uniformly applying the governing criteria for awarding the Air Medal (USARV Regulation 672-1). The results of the study indicated that no unreasonable exceptions were being made by I FFORCEV or units having authority to award the Air Medal -- the 173d Abn Bde, the 4th Inf Div and I FFORCEV Artillery. The Awards and Decorations Section processed an average of 553 awards per month for the three-month period (Inclosures 12, 13, 14).

(5) Rest and Recuperation: During the quarter ending 30 Apr 69, several new policies were introduced by MACV. The most noteworthy change was in allowing military personnel to wear civilian clothing on R&R flights to all sites other than Hong Kong, Bangkok and Taipei. The Government of Australia has granted authority to extend to a maximum of 72 hours the period in which the required medical examination of R&R personnel is to take place prior to their departure for Australia. Personnel entering Hawaii via R&R aircraft are restricted to \$100 worth of merchandise for personal or household use, one gallon of alcoholic beverages and not more than 100 cigars. Personnel on leave are no longer permitted to be manifested "Space Required" on R&R flights. This command received an average of 646 allocations per month (Incl 15).

(6) Civilian Personnel Management:

(a) Civilian personnel management during the period was satisfactory in both administration and pay. Coordination was maintained throughout the quarter between the area civilian personnel office and all levels of command. During the period, the local national direct hire spaces decreased from 283 to 279.

(b) I FFORCEV AIC Fund allocation from USARV for 2d Qtr CY 69 (\$3,405,000 \$VN) has been received and suballocated to units based on previous expenditure data and requirements.

CONFIDENTIAL

CONFIDENTIAL

AVFA-GC-07

15 May 1969

SUBJECT: Operational Report of Headquarters, I FFORCEV for Quarterly Period Ending 30 April 1969 RCS CSFOR-65 (R1) (U)

(7) Chaplain Activities:

(a) Significant activities:

1. The following personnel changes took place during the quarter: The 32d Chap Det was assigned to HQ I FFORCEV effective 15 Feb 69 with assigned strength of 4 chaplains and 4 assistants. One chaplain was assigned to 5th Bn, 27th Arty.

2. II CTZ has 119 Military Chaplains and 24 ROK Chaplains.

(b) Religious Services:

1. Military units in the II CTZ are adequately covered by Protestant Chaplains, and there are no current problems in providing coverage for Protestant personnel in the Zone. Travel continues to consume a vast amount of time in providing coverage for MACV Teams, MATS Teams and Special Forces units. Coverage for these teams, however, improved during the quarter with most teams receiving weekly coverage rather than bi-weekly as was experienced in the previous quarter.

2. The Catholic program has shown considerable improvement, with an increase in the number of Catholic Chaplains assigned to II CTZ. Problems in providing coverage for Catholic personnel in selected areas still exist, and some areas employ civilian clergymen to off-set the lack of sufficient Catholic Chaplains. Catholic coverage for MACV, MATS, and Special Forces Camps has shown an improvement similar to Protestant coverage.

3. Jewish area coverage is adequate. Lay Leaders continue to be used to organize and conduct lay services for Jewish personnel in the II CTZ. The Jewish Staff Chaplain conducted a Lay Leader Training Conference for all Jewish Lay Leaders to improve their work. Approximately 70% of the Jewish Chaplain's time is consumed in visiting Jewish personnel outside the Nha Trang area. During this quarter, the Jewish Staff Chaplain introduced Lox and Bagels for Jewish personnel in conjunction with their religious program.

4. In the Nha Trang area the following services are conducted:

a. Sunday: 23 Protestant, 12 Catholic, one Lutheran, two Episcopal, one Christian Science and one Latter Day Saints.

b. Weekday: Friday - Jewish Services, Saturday - Jewish Services, Daily - 3 Masses. Discussion groups are held in the 8th Field Hospital and I FFORCEV Chapel for Protestant Personnel.

(8) Military Police:

(a) Fatal Traffic Accidents: Traffic accidents resulting in death numbered 74 throughout II CTZ. These accidents resulted in 24 US deaths, six ARVN deaths, and 43 civilian deaths. A review conducted recently indicates that between US and VN deaths, approximately half were the fault of US drivers.

CONFIDENTIAL

CONFIDENTIAL

AVFA-GC-07

15 May 1969

SUBJECT: Operational Report - Headquarters, I FFORCEV for Quarterly Period Ending 30 April 1969 RCS CSFOR-65 (R1) (U)

(b) Serious Incident Reports: Serious incidents for the reporting period number 314. Seventy-five of these concerned Fatal Traffic Accidents and 43 concerned Aggravated Assaults.

(c) Distinguished Visitor Security: During the reporting period, the 272d MP Co provided security for 62 visiting VC's and flag officers or civilian equivalent and provided one trail vehicle for CG, I FFORCEV daily.

(d) Security and traffic control continue to be provided by the 272d MP Co for conferences and special events such as the Zone Coordinators II CTZ Senior Commander Conference, and classified briefings attended by CG, I FFORCEV and staff. Coordination was also made by the PM Section with the Vietnamese, ROK and other US agencies for the Change of Command Ceremony recently held at I FFORCEV Headquarters.

(e) Installation Security Inspection and Practice Test Exercises: A PM representative accompanies an I FFORCEV inspection team on inspections of major US installations in II CTZ. Installation Security Inspections of nine installations were conducted during the reporting period. The PM portion of the inspection is mainly concerned with the identification and control of local national employees.

(f) PM Section, I FFORCEV, establishment a pilot model of a Black-market Suppression team. As suitable data is developed, this pilot model may serve as a guide for other similar headquarters to follow.

(g) A study is underway to determine the source of blackmarket goods for the Nha Trang area. This data will be evaluated in the future for appropriate actions.

(9) Medical:

(a) The health of the command remains excellent. The decrease in the malaria rate experienced last quarter has continued through this report period. This is in part due to an expected seasonal drop and in part to further benefits from command emphasis on malaria preventive measures. The value of the urine chloroquine test has been pointed out in the previous report.

(b) Physician personnel in all units assigned, attached, and OFCOM to I FFORCEV are near 100% level. Only I FFORCEV Artillery is short. They currently are assigned 12 surgeons against an authorized 13 surgeons.

(c) The 68th Med Det (Helicopter Ambulance) which became operational on 10 Jan 69 has during this report period become firmly integrated into the support plan of the 43d Medical Group and has greatly improved the helicopter evacuation capability in southern II Corps.

(10) Morale and Welfare Services:

(a) The G1 staff continued to exercise staff supervision over the operation and administration of all non-appropriated fund activities within assigned and attached units. These activities include unit funds, sundry funds and open messes.

CONFIDENTIAL

CONFIDENTIAL

AVFA-CC OT

15 May 1969

SUBJECT: Operational Report of Headquarters, I FFORCEV for Quarterly Period Ending 30 April 1969 RCE CSFOR-65 (R1) (U)

(b) At the end of the reporting period, three officers Open Messes, two NCO/EM Open Messes with one annex each, one MACV Pres. Camp open Mess and one Other Sundry Fund were operational within this command. The reduction of other Sundry Funds is a result of instructions from this headquarters directing all other Sundry Funds to annex to an existing Open Mess in the area NIT 26 Apr 69. This was accomplished with the exception of the 5th Bn, 27th Arty Other Sundry Fund which was given a one month extension to complete annexation.

(c) Exchange services during the period continued to be adequate. A command letter was distributed to sub-zone and area coordinators, and the commander of ROKFV-FC, informing them that effective 1 May 69, patronage of US exchanges would be limited to US personnel and patronage of ROK exchanges would be limited to ROK personnel. This was necessary to insure equitable distribution of high demand merchandise to those individuals comprising the population density used as a basis for requisitioning merchandise, to reduce travel time between exchanges and to reduce crowded conditions in the various exchanges.

(11) Safety and Accident Prevention:

(a) The I FFORCEV Safety Program was reviewed for the third quarter FY 69, and statistics are included at Incl 16 and 17. Army Motor Vehicle accidents and accidental gunshot wounds continue to contribute the greatest number of accidents to our record. However, both have decreased during the third quarter.

(b) Safety regulation is being revised to include administration, organization, inspection and reporting requirements and a safety awards program.

(c) A "Certificate of Safety" has been designed and will be used as an individual award. It will also be presented with safety trophies as unit safety awards.

(d) The Safety Director arrived in late March, and a Safety Office has been established.

g. (C) Artillery

(1) Intelligence: Hostile enemy artillery attacks for the month of February reached a high point on the 22d with the initiation of the Post-Tet Offensive. On this day, the enemy conducted 46 attacks expending a total of 1160 rounds. Enemy artillery attacks continued to be high during the month of March in what was considered Phases II and III of the offensive. During the month of April, a significant decrease in the number of enemy artillery attacks was experienced. This probably can be attributed to the enemy's inability to maintain a continuous flow of ammunition and supplies to units located throughout II CTZ. The primary tactic of the enemy during all phases of the Post-Tet Offensive was use of indirect fire weapons. The enemy employed a variety of weapons in these attacks to include 60, 81, 82 and 122mm mtr; 122 and 140mm rkt; 57 and 75mm recoilless rifles, 85 and 100mm gun and 105mm howitzers. During the three phases of the Post-Tet Offensive, the enemy was primarily oriented towards rural areas, LOC's and military installations.

CONFIDENTIAL

CONFIDENTIAL

AVFA-GC-OT 15 May 1969
SUBJECT: Operational Report of Headquarters, I FFORCEV for Quarterly
Period Ending 30 April 1969 RCS CSFOR-65 (R1) (U)

(2) Operations:

(a) During the reporting period, artillery units with I FFORCEV continued support of ARVN, ROK, US RF/PF, KD Teams and USSF/CIDG forces in II CTZ. The I FFORCEV Prov Arty Gp was organized on 10 Apr 69 as part of the change in deployment and organization of I FFORCEV maneuver forces in order to provide maximum participation in pacification, fire planning, and artillery protection for the greatest number of villages and hamlets in the II CTZ. Attached to the Prov Arty Gp are the 5th Bn, 27th Arty, which previously was a separate battalion, and the 5th Bn, 22d Arty, which was detached from the 52d Arty Gp Btry C, 2d Bn, 320th Arty and Btry C, 3d Bn, 319th Arty were released from operational control of TF South and placed under the operational control of the Prov Arty Gp.

(b) The 4th Inf Div and the 52d Arty Gp were given the added responsibility for AO MARSHALL and the northern half of Binh Khe District in Binh Dinh Province. Concurrent with this change in responsibility, the 2d Bn, 17th Arty (-), which had been attached to the 41st Arty Gp, was attached to the 52d Arty Gp. For command and control purposes, C Btry, 7th Bn, 15th Arty was attached temporarily to 2d Bn, 17th Arty (-), and C Btry, 2d Bn, 17th Arty was attached temporarily to the 7th Bn, 15th Arty.

(c) Btry B, 29th Arty (SLT), which is subordinate to the 4th Bn, 60th Arty, has received six of the new 30 inch Xenon searchlights which are in addition to its 36 standard 23 inch lights. The 30 inch lights are located at "LZ Uplift", Ky Son, An Khe, Phan Thiet, "Artillery Hill" just north of Pleiku and Phan Rang. Five of them are operational. The sixth one does not have a generator.

(3) Fire Support Coordination Element (FSCE)

(a) An average of three naval ships were on station during the period. Naval gunfire continues to play a major and vital role in providing continuous, responsive fire support to all FVMAF/RVNAF operating along the coast of II CTZ. The USS New Jersey supported TF South and 9th ROK Inf Div during the period 21-28 Mar 69. Four hundred ninety-seven 16-inch rounds were expended, and 24 probable enemy KIA were reported. During the early morning of 24 Feb 69, the city of Nha Trang came under mortar attack. The USS Lynde McCormick (DDG-8), conducting a night patrol in the vicinity of Nha Trang, provided Naval gunfire support. The following are the total expenditures for naval gunfire support during the period:

<u>MISSIONS</u>	<u>TARGETS</u>	<u>ROUNDS</u>
496	2,101	27,372

(b) During the period 1 Feb - 30 Apr 69, a daily average of 63 immediate reaction/hangfire targets were developed of which an average of 40 were fired daily. A total of 5745 immediate reaction, 527 hangfire and 1788 other targets were developed by the I FFORCEV FSCE during this period.

CONFIDENTIAL

CONFIDENTIAL

AVFA-GC-OT

15 May 1969

SUBJECT: Operational Report of Headquarters, I FFORCEV for quarterly
Period Ending 30 April 1969 RCS CSFOR-65 (R1) (U)

(c) The Enemy Area Harassment Program was established to harass the enemy in areas generally not within artillery range and outside normal operating areas of friendly troops. The program was initiated on 1 Mar 69. Nine areas were originally selected eight of which have received heavy fire support. One area has received negligible support due to its continuing low priority relative to the others. Five areas have had primary interest, and two additional areas have been selected since the start of the program. Following is the fire support summary since initiation of this harassment program

<u>A/C SORTIES FLOWN (F4/F100)</u>	<u>SPOOKY/SHADOW (RDS)</u>	<u>ARTILLERY (RLS)</u>
275	270,000	905

(d) During the quarter, FSCE issued a daily average of eight 175mm gun suppressions for ARC LIGHTS.

(e) On 5 Feb 69 FSCE assumed I FFORCEV staff responsibility for the ARC LIGHT program. Prior to this date, responsibility was divided between FSCE and G3 Air. The transition of duties was accomplished without difficulty or loss of continuity in support. In its new capacity, the FSCE presents ARC LIGHT briefings for officers newly assigned to II CTZ whose duties involve the ARC LIGHT program. During the period, an ARC LIGHT briefing was conducted by a MACV briefing team and was well attended by I FFORCEV staff members and representatives from subordinate and allied commands.

(4) RVNAF assistance programs continued to show progress during the reporting period. Survey control has been extended to most ARVN artillery positions, and advances have been made in the transmission of meteorological messages to ARVN artillery units. Consequently, an increase in the use of MET plus VE corrections by ARVN artillery has been noted.

(b) Increased emphasis has been placed on artillery assistance to RF/PF units, RD Teams, and PSDF. Field grade artillery commanders have been assigned specific districts for which they are responsible for coordinating artillery assistance. Current goals are to review and strengthen all territorial force fire plans, to increase the level of trained forward observers and to generate more fire missions from territorial force units.

(c) As a part of the accelerated Phase II plan for RVNAF Improvement and Modernization, 6th Bn, 84th Arty has been scheduled for turnover to the ARVN 45th Arty Bn. Approval of the turnover was granted by MACV on 2 Apr 69. Btry C completed turnover of its equipment on 18 Apr 69. Btry B and Btry A are scheduled for turnover on 15 Jun and 15 Jul, respectively.

(5) Artillery Seminars: The Fourth Allied Artillery Seminar was hosted by CO, 9th ROK Division Artillery, on 30 Apr 69. Senior Commanders and selected staff officers of ARVN, ROK and US artillery organizations attended. Topics were presented by each ally. A

CONFIDENTIAL

CONFIDENTIAL

AVFA-GC-01 15 May 1969
SUBJECT: Operational Report of Headquarters, I FFORCEV for Quarterly
Period Ending 30 April 1969 RCS CSPCR-65 (R1) (U)

discussion was held concerning the current problems in rendering support to RF/PF units. The seminar was terminated by a graphic demonstration of self defense fire by ROK artillerymen.

(b) Artillery Organization, II CTZ

(a) Non-divisional.

I Field Force Vietnam Artillery

4th Battalion, 60th Artillery (AWSP)

Battery B, 29th Artillery (SLT)

Battery E, 41st Artillery (MG)

6th Battalion, 32d Artillery (175mm/8inch SP)

Headquarters Battery, 9th Battalion, 26th Artillery (TAB)

77th Field Artillery Detachment (Radar)

237th Field Artillery Detachment (Radar)

241st Field Artillery Detachment (Radar)

242d Field Artillery Detachment (Radar)

243d Field Artillery Detachment (Radar)

244th Field Artillery Detachment (Radar)

253d Field Artillery Detachment (Radar)

254th Field Artillery Detachment (Radar)

255th Field Artillery Detachment (Radar)

256th Field Artillery Detachment (Radar)

41st Artillery Group

7th Battalion, 13th Artillery (105mm T)

7th Battalion, 15th Artillery (-) (with C/2/17 temporarily attached) (155mm T, 175mm/8 inch SP)

6th Battalion, 84th Artillery (155mm T)

52d Artillery Group

3d Battalion, 6th Artillery (105mm SP)

6th Battalion, 14th Artillery (175mm/8 inch SP)

2d Battalion, 17th Artillery (with C/7/15 temporarily attached) (105mm T, 175mm/8 inch SP)

1st Battalion, 92d Artillery (155mm T)

CONFIDENTIAL
71

CONFIDENTIAL

15 May 1969

AVFA-GC-OT

SUBJECT: Operational Report of Headquarters, I FFORCEV for Quarterly Period Ending 30 April 1969 RCS CSPCR-65 (R1) (U)

I FFORCEV Provisional Artillery Group

5th Battalion, 22d Artillery (175mm/8 inch SP)

5th Battalion, 27th Artillery (attached B/6/84) (105mm T, 155mm T)

(b) Divisional, Brigade and Separate Battalion

4th Infantry Division Artillery

2d Battalion, 9th Artillery (105mm T)

5th Battalion, 16th Artillery (155mm/8 inch SP)

6th Battalion, 29th Artillery (105mm T)

4th Battalion, 42d Artillery (105mm T)

173d Airborne Brigade (Separate)

3d Battalion 319th Artillery (105mm T)

3d Battalion, 506th Infantry; 101st Airborne Division

Battery D, 2d Battalion, 320th Artillery (105mm T)

(7) Artillery Strength: The following table reflects artillery tube strength by caliber for ARVN, ROK, US and USSF/CIDG Artillery units in II CTZ at the end of the reporting period.

	<u>105mm</u>	<u>155mm</u>	<u>8 inch</u>	<u>175mm</u>
US Divisional	84	18	4	0
ROK Divisional	108	36	0	0
US Force Artillery	69	38	22	26
ARVN Artillery	125	48	0	0
Special Forces (CIDG)	<u>19</u>	<u>0</u>	<u>0</u>	<u>0</u>
TOTAL	405	140	26	26
GRAND TOTAL	597			

(8) Ammunition statistics for US Artillery with I FFORCEV during the reporting period

CONFIDENTIAL

CONFIDENTIAL

AVFA-GC-OT

15 May 1969

SUBJECT: Operational Report of Headquarters, I FFORCEV for Quarterly
Period Ending 30 April 1969 RCS CSFOR-65 (R1) (U)

a. Expenditures by target category

TARGET CATEGORY	FEBRUARY ROUNDS/MISSIONS	MARCH ROUNDS/MISSIONS	APRIL ROUNDS/MISSIONS
CONFIRMED	34,281/1,547	53,782/1,754	23,515/1,020
ACQUIRED	77,303/12,530	100,033/14,056	44,907/8,259
COUNTERBATTERY	7,699/453	18,824/887	3,826/250
PREPARATION	14,753/644	22,367/1,074	1,890/876
INTERDICTION	31,396/10,631	16,377/7,239	10,714/5,899
SPECIAL PURPOSE	20,423/2,731	25,708/3,119	21,808/2,390
OTHER	<u>2,868/387</u>	<u>3,542/413</u>	<u>2,518/314</u>
TOTAL	188,723/28,723	240,633/28,542	120,976/19,008

b. Expenditures by caliber:

MONTH	CALIBER	RDS EXPENDED	% OF TOTAL	RDS/TUBE/DAY
Feb	105mm	118,291	63%	28
	155mm	33,232	18%	19
	8 inch	17,392	9%	24
	<u>175mm</u>	<u>19,808</u>	<u>10%</u>	<u>27</u>
	Sub Total	188,723	100%	25*
Mar	105mm	164,281	68%	35
	155mm	44,077	18%	23
	8 inch	14,568	6%	18
	<u>175mm</u>	<u>17,707</u>	<u>8%</u>	<u>22</u>
	Sub Total	240,633	100%	25*
Apr	105mm	81,252	67%	18
	155mm	20,240	16%	11
	8 inch	8,015	7%	10
	<u>175mm</u>	<u>11,469</u>	<u>10%</u>	<u>15</u>
	Sub Total	120,976	100%	14*
GRAND TOTAL		550,332		

*Prorated Average

CONFIDENTIAL

CONFIDENTIAL

AVFA-CC-OT

15 May 1969

SUBJECT: Operational Report of Headquarters, I FFORCEV for Quarterly
Period Ending 30 April 1969 RCS CSFOR-1965 (A) (U)

h (C) Signal Operations:

(1) The continuing upgrade of communications systems and circuits within the II CTZ was the major concern of the Signal Section during the past quarter.

(2) The 54th Sig Bn continued to support units within the II CTZ. A special radioteletype command net was set up to support Co B, 5th SFG on an operation at Bu Prang. Radioteletype Command Net Alpha was expanded to include a new station from 21st Sig Gp Hqs. A multi-channel VHF radio system was installed from LZ English to LZ English North, LZ English to LZ Uplift, An Khe to LZ Ellen, Tuy Hoa to 6th Bn, 32d Arty firebase, and CAP KOK Inf Div through Monastery Hill to Tiger Div Forward CP. FM radio support was furnished to KOK SR LNO and to DFSA Binh Thuan.

(3) A combined cable team composed of members of the 54th Sig Bn and the 459th Sig Bn continued to police the cable within the Nha Trang area. Various public address systems were installed and operated for conferences and ceremonies held at Hqs, I FFORCEV.

(4) A second 100 work-per-minute MODE V AUTODIN circuit was activated from I FFORCEV COMMCEN to Nha Trang Automatic Switching Center for additional access into the World-Wide AUTODIN Digital Network. The Signal Section continued in its resolution of frequency interference, SOI compromise and distribution and security problems. The Signal Section aided the IG in conducting several semi-annual inspections of attached units. Work continued on the Telephone Circuit Quality Control Program, Command Crypto Facilities inspections, Village/Hamlet radio system, PSA communications surveys, publication/distribution of telephone directories and AIG's, and the Communications Data Analysis program.

i. (C) Engineer:

(1) During the period of this report the engineer section directed effort towards planning, coordinating and monitoring of engineer activities in II CTZ and maintained close contact with engineer units by frequent field trips. Staff projects during this period included:

(a) MIP Program III-6, I FFORCEV Highway Improvement Program (Engr/G-3): As a part of this project, a joint action between this section and the 64th Engr Det (T) was initiated during the last report period to accumulate and catalogue ground and aerial photographs of all bridges on main LOC's in II CTZ. As of 30 Apr 69, the project is 82% complete.

(b) MIP Program III-5, I FFORCEV Airfield Improvement and Maintenance Program (Engr/G-4): Following a decision briefing on 24 Mar 69, the CG, I FFORCEV, approved the revised airfield maintenance standards. On 28 Mar 69, a letter was dispatched to MACCS, US.MV, 4th Inf Div, 1st Log Cnd, 16th Engr Bde, 17th Abn Bde, 834th Air Div, DEPCORUS, DSA II Corps, 1F South, 5th SFGA and the 17th Avn Gp. The intent of the letter was to inform the users and units responsible for airfield maintenance of the required standard.

CONFIDENTIAL

CONFIDENTIAL

AVFA-GC-07

15 May 1969

SUBJECT: Operational Report of Headquarters, I FFORCEV for quarterly Period Ending 30 April 1969 RCS CSFOR-65 (R1) (U)

(c) A study of tactical bridge requirements in II CTZ was completed, and a contingency plan was transmitted to CG, USAHV, with information copies to appropriate II CTZ units and commands. The 18th Engr Bde has adequate bridging, although they are presently re-positioning some bridging to satisfy contingency requirements.

(d) The Engr Annex to I FFORCEV's OPLAN for the withdrawal phase of post hostilities planning Vietnam was staffed and completed during this quarter.

(e) Annex J (Engr) to II CTZ Combined Campaign Plan, 1969 (U) is in process of being rewritten and will be completed during the next report period to reflect changes in priorities and to provide an updated document for the last half of CY 1969.

(f) The MACV Advisor Facilities upgrade program continues to be monitored and that portion presently assigned to troop construction is approximately 49% complete. USAECAV is making surveys of the remaining 31 water wells required and plan to award these to civilian contractors in June. The 17 sites not assigned to troop construction are in the design stage at OICC and scheduled to be awarded to civilian contractors.

(g) Letter, USAHV, AVHEN-CD subject: Integrated Priority Lists, dated 25 Mar 69, tasked CG, I Field Force, Vietnam, in his capacity as II CTZ Coordinator, with the responsibility of developing recommended integrated priority lists for contract construction for the Central (Cam Ranh - Nha Trang) area. The list was prepared and submitted to MACDC-BD on 1 Apr 69 for the 2d Quarter CY 69. Information copies were forwarded to USAHV AITN: AVHEN-CD. Priorities were established in accordance with letter, MACDC-PO, subject: Priority for Facilities to Support RVNAF Improvement, dated 15 Dec 68. The Engineer will continue to develop this list on a quarterly CY basis. The next listing is due to MACV on 1 Jul 69.

(2) Support of Tactical Operations:

(a) DAN AN/SHERIDAN: Three Bn's of the 35th Engr Gp (Const), the 116th Engr Bn (Cbt), the 577th Engr Bn (Const), and the 589th Engr Bn (Const) provided general engineer support within this area.

1. The 116th Engr Bn (Cbt) assisted throughout the period in improvement of fire support bases LZ Sandy and LZ Sherry. Projects including construction of 175mm Howitzer reinforced concrete gun pads at LZ Sandy and seven guard towers, clearing of fields of fire and protective berms and construction of showers, latrines and mess halls.

2. The 116th Engr Bn (Cbt) also provided DS to 1st Bn, 506th Inf and territorial forces on a recurring basis in conducting mine sweeps and bunker destruction missions vicinity of Phan Thiet.

3. Construction of the PSB at Tan My began in the previous reporting period by the 589th Engr Bn (Const) and was completed 24 Feb 69. Facilities constructed included two 155mm Howitzer positions, two guard towers, clearing of fields of fire, protective berms, living/fighting bunkers and a mess hall.

CONFIDENTIAL

CONFIDENTIAL

AVFA-GC-01

15 May 1969

SUBJECT: Operational Report of Headquarters, I FFORCEV for Quarterly
Period Ending 30 April 1969 RCS CSPOR-65 (R1) (U)

4. Similar construction, as listed above, was provided by the 577th Engr Bn for the fire support base at Duc Trung and continued during the period of this report.

(b) DAN/QUYEN HINES:

1. During the period of this report, the 20th Engr Bn (Cbt) and 299th Engr Bn (Cbt) of the 937th Engr Gp (Cbt) provided general engineer support within this operational area which included the provinces of Kontum, Pleiku and the majority of Phu Bon.

2. Daily minesweeps continued throughout this period on RP 512 and QL-14 from Pleiku to road junction with RP 512 near Dak To.

3. Rome flows from the 20th Engr Bn (Cbt) cleared secondary growth along QL-14 north of Pleiku in areas cleared last year.

4. Elements of the 20th Engr Bn (Cbt) expanded and peneprimed a helicopter operational area for Special Forces at Duc Co in March.

5. As a result of a successful enemy sapper attack on Tank Farm #2 in Qui Nhon in the latter part of March, extensive improvements and developments of security facilities in 1st Log facilities within II CTZ were initiated and are still being accomplished at the end of this reporting period.

(c) DAN/CUONG LEE:

1. Daily minesweeps of QL-1 from Bong Song to the northern border of II CTZ were conducted by the 19th Engr Bn (Cbt).

2. Early in April, engineer operational support was extended to the MACV Advisory team at Tam Quan consisting of building living quarters, latrine, showers and other necessary operational team facilities. The project is scheduled for completion early in May.

(d) AO MARSHALL:

1. During the first half of this reporting period, the 20th Engr Bn (Cbt) constructed 12 helicopter revetments and ammo storage and re-arming points for D Trp, 2d Sqdn, 1st Air Cav, at An Khe Golfcourse.

2. A platoon of the 20th Engr Bn (Cbt), also commenced in April, the construction of 12 additional revetments and ten maintenance revetments adjacent to the Golf Course parking apron for the newly arrived 238th AWC. This project was completed during the last week of April.

3. The An Khe Central power plant was reveted during this period by the 20th Engr Bn (Cbt)

4. Improvements of the security facilities around the POL tank farm at Camp Radcliff were initiated in April. Construction includes the improvement of the berms around each tank and the placement of chain link fence around each tank at a height of 24 feet or the top of the tank, whichever is less.

CONFIDENTIAL

CONFIDENTIAL

AVFA-GC-OT

15 May 1969

SUBJECT: Operational Reports of Headquarters, I FFCRCEV for Quarterly Period Ending 30 April 1969 RCS CSFOR-65 (R1) (U)

(e) II CTZ:

1. A single lane, limited all-weather road (TL-2E) was constructed from vicinity of Buon Blech for 17 km to Thuan Man by the 20th Engr Bn (Cbt) as the initial step to opening the area between Buon Blech and Cheo Reo for resettlement of refugees and provide an LOC for the planned re-establishment of a District Headquarters at Thuan Man.

(j) Airfield Upgrading and/or Repair:

(a) An Khe (BR 478447): One platoon of the 20th Engr Bn (Cbt) continued repair of two taxiways entering the parking apron and the parallel taxiway. This project consists of removing the M8A1, excavating the old subgrade and placing the compacting new subgrade and M8A1. During this reporting period, the southern taxiway was completed and opened. The earthwork on the remaining taxiway has been completed and is expected to be operational early in May 69.

(b) Ban Me Thuot City (AQ 800038): Rehabilitation of four revetments begun during last reporting period were completed on 11 Feb 69 by the 70th Engr Bn (Cbt).

(c) Ban Me Thuot East (AQ 868020): Construction of a temporary taxiway started within the last period was completed in February. It is now in use while GVN rehabilitates the western half of the primary runway.

(d) Bao Loc (ZT 065792): Continuing maintenance was performed on Bao Loc airfield by the 116th Engr Bn (Cbt). Repairs included removal of damaged M8A1 matting, stabilization of the sub-base using soil cement, sealing with asphaltic cutback, placement of new M8A1 and application of anti-skid compound. Minor failures were welded on a continuing, as-needed basis.

(e) Ben Het (YB 872252): The 20th Engr Bn (Cbt) repaired damage caused by enemy shelling in March.

(f) Buon Blech (BQ 004599): The 20th Engr Bn (Cbt) completed the repair of the eroding runway shoulder on the north-west end in March by placing terraced sandbags covered with peneprime.

(g) Cheo Reo (BQ 233818): The 20th Engr Bn completed repair of the north runway in April by excavating soft areas and replacing new compacted fill and capping with concrete. The field will be opened to C-130 traffic on or about 10 May after the concrete caps are sufficiently cured.

(h) Dalet Cam/Ly (BP 185220): The 589th Engr Bn (Const) repaired a slope failure at the west end of the runway, as well as making several patches in the runway surface.

(i) English Airfield (BS 879005): The asphaltic concrete runway was completed on 17 Apr 69 by the 19th Engr Bn (Cbt) and was opened to C-130 traffic the same date.

CONFIDENTIAL

CONFIDENTIAL

AVFA-GC-OT

15 May 1969

SUBJECT: Operational Report of Headquarters, I FFORCEV for Quarterly Period Ending 30 April 1969 RCS CSFOR-65 (R1) (U)

(j) Lac Thien (AP 975756): The existing PSP matting was extended 450 feet by providing a soil extension and concrete transition ramp from the PSP to the extension was to meet aviation safety requirements for O1 aircraft. Project was completed on 7 Apr 69.

(k) Nha Trang (CP 039520): A C-7A ramp utilized by 5th SFGA was rehabilitated between 7 Feb 69 and 12 Apr 69. Damaged PSP surface was replaced with asphaltic concrete.

(l) Phu Heip (CQ 245364): Five helicopter revetments were completed 18 Mar 69 for the 68th Med Det (Dust Off). Project included construction of M8A1 pads and dust suppression.

(m) Ple Arong (ZA 114670): During this period, the 20th Engr Bn (Cbt) upgraded this airfield to Type I, C-7A by extending its length, placing a crown, adequate drainage, applying a peneprime seal coat and re-routing of the road by the airfield to the VN SFG camp.

(n) Polei Kleng (ZA 0299335): Following extensive damage inflicted by an enemy mortar and rocket attack in mid-March, the 20th Engr Bn repaired the major damage in the same month. The field is still closed to AF aircraft at the end of this report period pending relocation of infantry and artillery defensive positions and fortifications built in contradiction to existing Air Force requirements. The field is heavily used by 4th Inf Div helicopters and corrective action to open the field to Air Force aircraft prior to the pending SW monsoon season is in progress.

(o) Throughout the period of this report, dust suppression operations were conducted as needed at Ban Me Thuot East, Phan Thiet, Bao Loc, Dak Seang and Dak To. RC-3 was the principal agent applied.

(4) Land Clearing Operations:

(a) In the 937th Engr Gp ACR, a total of 4,715 acres were cleared by Rome plows along QL-14 between Ban Me Thuot and Kontum.

(b) In the 35th Engr Gp ACR, a total of 4,609 acres were cleared during this reporting period along QL-20, QL-21A and LTL-7B.

(5) Route Upgrading in II CTZ:

(a) Within the 937th Engr Gp ACR, during the period of this report, a total of 20.87 km of LOC's were restored to all weather standard, which included 671 meters of culvert replaced or installed. The majority of this effort was expended on QL-14. A total of 24.41 km of QL-14 was improved and paved to MACV standards, and QL-19E paving to MACV standard was completed in April. As of 30 April, all of QL-1 from the II CTZ northern border to within two miles of Bong Song were paved to MACV standard by the 19th Engr Bn (Cbt). The remaining two miles yet to be paved are scheduled to be completed in May of the following report period. Pioneer and earthwork on QL-1 from Qui Nhon to Tuy An continued throughout this report period, accomplished by the 84th Engr Bn (Const) in preparation for funded paving to MACV standard by civilian contractors during this calendar year. The 299th Engr Bn (Cbt)

CONFIDENTIAL

CONFIDENTIAL

AVFA-GC-OT

15 May 1969

SUBJECT: Operational Report of Headquarters, 1 FFORCEV for Quarterly Period Ending 30 April 1969 RCS CSFOR-65 (R1) (U)

continued upgrading Rt 512 to an all weather, single lane IOC throughout this period by placement of a durable asphalt road mix. This project on Rt 512 is scheduled for completion within the next report period prior to 25 May 69. The machine laid paving of QL-14 between Pleiku and Tan Canh continued throughout the period of this report and is scheduled for completion on or before 1 June 1969.

(b) Within the 35th Engr Gp (Const) AOR, a total of 41.08 km of road way were constructed to MACV standard. Paving was initiated on Routes QL-11 (7.58 km complete vic Phan Rang) and QL 21 (24.19 km complete vic Ninh Hoa). Construction to MACV standard continued on Route QL-1 between Tuy Hoa and Vung Ro Bay, where 6.98 km were completed during the period. This section is expected to be completed in the next period. 2.33 km of Route QL-1 were paved vic Ninh Hoa. Between the II/III CTZ boundary and Bao Loc, base course material was placed on 12 km of roadway as part of the phased rehabilitation to MACV standard of Route QL-20. A total of 632 meters of culvert were installed, and 34 bridges were repaired or improved. Upgrading and maintenance of QL-1, QL-11, QL-20, QL-21A and QL-21 will continue into the next reporting period.

(b) Miscellaneous Engineer Activities:

(a) An underground medical facility at Camp Coryell, Ban Me Thuot City was completed on 7 Apr 69. This is a timber structure fortified to permit continuous medical treatment even during enemy attack.

(b) General rehabilitation of the ISA area at Ban Me Thuot East continued throughout this reporting period. This included relocation of the Class I and IV areas. The berms, pads and roads in the ASP were improved and SEA huts constructed for troop housing.

(c) The FSB at Ban Me Thuot East was assisted by construction of gun pads, mess halls, bunkers and guard towers.

(d) Construction was completed on 15 Feb 69 of bunkers and revetments for a counter-mortar installation at Ban Me Thuot.

(e) Between 7 Mar - 1 Apr 69, construction was accomplished at the Ban Me Thuot PSYOPS radio station to improve security. This included extensive revetments to shield the transmitter building, berms at the tower and guy-line bases, and clearing of fields of fire.

(f) Counter-mortar radar installations were completed at Nha Trang on 15 Feb and at Dong Ba Thin in April 1969. Construction included bunkers, pads and revetments for the radar and, at Dong Ba Thin, lining facilities for the operating force.

(g) At Dong Ba Thin, facilities for the installation of a relocatable microwave relay were constructed by the 577th Engr Bn (Const) consisting of 15 foot revetments to shield the electronic van.

(h) Four steel guard towers were erected at Gia Nghia by the 116th Engr Bn (Cbt) to improve defenses of the MACV installation.

(i) Construction of an IST ramp was initiated at Phan Thiet in February and scheduled to be completed in May.

CONFIDENTIAL

CONFIDENTIAL

AVFA-GC-01

15 May 1969

SUBJECT: Operational Report of Headquarters, I FFORCEV for Quarterly
Period Ending 30 April 1969 RCS CSFOR-65 (R1) (U)

(j) During this period, a POL tank farm at Dalat consisting of one 3,000 bbl tank and three 500 bbl tanks was nearly completed and the construction of a new ASP was initiated.

(k) In Nha Trang, the new I FFORCEV Artillery Headquarter building was 95% complete at the end of the period.

(l) At Bao Loc, fifteen SEA huts were constructed in the ISA area and 34 within the 3d Bn, 503d Inf for troop housing and community facilities.

(m) Engineer technical and equipment assistance was provided at Pr'line, Bong Bien, and Hon Tre signal sites for installation of Dufflebag equipment.

j. (U) Information.

(1) Representatives of the Information Office provided coverage for numerous awards and promotion ceremonies as well as for special events during the period, including:

(a) I FFORCEV Art'y ground breaking ceremony - 5 Feb 69.

(b) Change of Command, 17th Cbt Avn Gp - 6 Feb 69.

(c) Presentation of Legion of Merit to LTC Hammack - 6 Mar 69.

(d) Promotion of LTC Corcoran to his present rank - 14 Mar 69. (Incl 17)

(e) I FFORCEV Change of Command - 14 Mar 69. (Incl 19, 20)

(f) I FFORCEV Art'y Change of Command - 16 Mar 69.

(g) Presentation of Legion of Merit to Col Black - 11 Apr 69.

(h) Presentation of Legion of Merit to Col Neff - 19 Apr 69.

(i) Presentation of Legion of Merit to LTC Fessenden - 20 Apr 69.

(j) Presentation of Legion of Merit to LTC Ferullo - 21 Apr 69.

(k) Presentation of Legion of Merit to LTC Rafferty - 21 Apr 69.

(l) Presentation of Legion of Merit to Col Delemeter - 22 Apr 69.

(2) Photographic coverage was provided for numerous distinguished visitors to include the visit of Gen Haines, CG, USARPAC on 13 Feb 69.

(3) The following Media representatives were granted an interview with the CG and/or G2/G3 briefing during the period covered by the report.

(a) Bill Collins, Stars & Stripes - 13 Mar 69.

(b) Francois Sully, Newsweek - 26 Mar 69.

(c) Bob Kaylor, UPI - 27 Mar 69.

CONFIDENTIAL

UNCLASSIFIED

AVFA-GC-CT

15 May 1969

SUBJECT: Operational Report of Headquarters, I FFORCEV for quarterly
Period Ending 30 April 1969 RCS CSFOR-65 (A1) (U)

(d) Peter Arnette AP - 2 Apr 69

(4) Command Information Initial Orientation Briefings for personnel newly assigned to I FFORCEV were conducted twice monthly.

(5) The 5th PID under the supervision of the IO, I FFORCEV published and distributed its "Morning News" on a daily basis, and a bi-weekly summation of news in II CTZ, the "WRAP-UP". The 5th PID also produced a weekly 15 minute radio program, the "Feature Page". The I FFORCEV magazine, "TYPHOON", was published in February, March and April. Maj Edward C. Allen assumed command of the 5th PID on 11 Feb 69. Maj Martin C. Froebel, former CO of the 5th PID, departed for CONUS on 27 Feb 69.

(6) The 11th PID continued to provide transportation, escort, billets and other aid to correspondents and visiting information personnel, handling 336 during the period covered. On 7 Apr 69, the 11th PID assumed responsibility for publishing and distributing the "Morning News".

k, (U) Inspector General Activities:

(1) Major Devon W. Fields was assigned to the Office of the Inspector General, this headquarters, on 21 Apr 69 to assume the duties of Acting Inspector General.

(2) During the period, 108 Inspector General Action Requests were received. Three trends were detected concerning delay in receipt of reassignment orders, harassment and poor morale and inequities in distribution of Hawaii R&R allocations to MACV advisory personnel.

(a) The matter of delay in receipt of reassignment orders was reported to USARV IG thru inspector general technical channels. In addition, it was reported by letter from CG, I FFORCEV to DCG, USARV. It was indicated that delays are the result of late reporting of personnel for reassignment by units and late receipt of reassignment orders from Department of the Army. During visit of the Inspector General, Department of the Army, on 26 Apr 69, this matter was presented to him as an item for inspection of the Department of the Army staff.

(b) Thirty four complaints concerning harassment and poor unit morale were received. In each case, it was determined that unjustified allegations were made against a newly arrived commander officer or first sergeant who were correcting improper procedures and low standards of appearance and discipline that had been permitted in the past. This trend is considered beneficial to the command.

(c) A trend of complaints from MACV advisory detachments indicates an unequal distribution of Hawaii R&R allocations to MACV advisory personnel. This matter is under inquiry, and upon completion will be reported through inspector general technical channels for resolution.

(3) Command Inspections of the following units were conducted on the dates indicated:

UNCLASSIFIED

UNCLASSIFIED

15 May 1969

AVFA-GC-OT
 SUBJECT: Operational Report of Headquarters, I FFORCEV for Quarterly
 Period Ending 30 April 1969 RCS CSFOR-65 (R1) (U)

<u>Unit</u>	<u>Date</u>
107th Sig Co	7 Feb 69
HHB 41st, Arty Gp	10 Feb 69
HHB 52d Arty Gp	17 Feb 69
Co C (Ranger) 75th Inf	21 Feb 69
2d Bn 17th Arty	3 Mar 69
Binh Dinh Prov Adv Tm	4 Mar 69
41st CA Co	7 Mar 69
Kontum Prov Adv Tm	11 Mar 69
4th Bn 60th Arty	17 Mar 69
11th PI Det	15 Mar 69
55th MI Det	15 Mar 69
64th Engr Det	15 Mar 69
Quang Duc Prov Adv Tm	18 Mar 69
Ninh Thuan Prov Adv Tm	24 Mar 69
HHB IFV Arty	29 Mar 69
8th Bn 26th Arty	7 Apr 69
Binh Thuan Prov Adv Tm	8 Apr 69
272d MP Co	11 Apr 69
Lam Dong Prov Adv Tm	15 Apr 69
5th Bn 27th Arty	21 Apr 69
Phu Bon Prov Adv Tm	22 Apr 69
Khanh Hoa Prov Adv Tm	24 Apr 69
297th Trans Co	25 Apr 69
6th Bn 32d Arty	26 Apr 69

(4) During the period, special security inspections were conducted of the following installations:

<u>Installation</u>	<u>Date</u>
Qui Nhon	14, 15 Mar 69
Phan Rang	24, 25 Mar 69

UNCLASSIFIED

UNCLASSIFIED

AVFA-GC-OT 15 May 1969
SUBJECT: Operational Report of Headquarters I FFORCEV for Quarterly
Period Ending 30 April 1969 RCS CSFOR-65 (R1) (U)

<u>Installation</u>	<u>Date</u>
Tuy Hoa	27, 28 Mar 69
Dong Ba Thin	3, 4 Apr 69
Pleiku	7, 8 Apr 69
Nha Trang	10, 11 Apr 69
Dalat	23 Apr 69

(5) All units inspected were rated satisfactory. Unsatisfactory areas found in Co C, 75th Inf (Ranger) were reinspected on 17 Apr 69, and found to be satisfactory.

(6) Memorandum, subject: Rights of Military Personnel to Prevent Complaints, was published and distributed on 1 Apr 69 to all assigned and attached unit.

(7) There were no investigations conducted during the period by the Inspector General.

(8) MG Enemark, The Inspector General, Department of the Army, visited this office on 26 Apr 69, and was briefed on inspector general activities in II CTZ.

1. (U) Staff Judge Advocate Activities:

(1) There were three trials by General Courts-Martial convened by the Commanding General, I FFORCEV, during the quarter compared to two cases the previous quarter while 244 special court-martial and 104 summary courts-martial were reviewed for legal sufficiency. This reflects a decrease of 21 special and 30 summary courts-martial over the previous quarter. Also during this period, there were 1858 Article 15's reviewed as compared with 1126 for the previous period.

(2) Sixty five claims of Arty personnel for loss of, or damage to, personal property incident to service were adjudicated and paid, compared to 28 the previous quarter. The claims totaling \$16,949.42 were approved for payment in the total amount of \$12,210.01

(3) Eighteen claims of Vietnamese nationals for personal injury or property damage were processed by this office.

(4) The legal assistance office provided advice and assistance on civil matters to 573 individuals during the quarter compared to 575 the previous quarter.

(5) Military justice clients numbered 139 during this quarter.

UNCLASSIFIED

UNCLASSIFIED

AVFA-GC-07

15 May 1969

SUBJECT: Operational Report of Headquarters, I FFORCEV for Quarterly
Period ending 30 April 1969 RGS CSFOR-65 (E1) (U)

m. (U) Command Analysis and Programs (CAP) Activities: During the period 1 Feb - 30 Apr 69, the Office of the Special Assistant, Command Analysis and Programs (CAP) continued to provide assistance to Headquarters, I FFORCEV in analysis of organization, functions and operations and in management improvement techniques. The Office of Command Analysis and Programs assisted in the following during the period of the report:

- (1) CAP provided assistance to G3 Air in preparing the preliminary draft of the I FFORCEV Tactical Air Expenditures Analysis System Booklet, which is designed to explain the system, and assist subordinate commands in analyzing tactical air expenditures and identifying trends in tactical air employment.
- (2) CAP prepared the I FFORCEV Organization and Functions Manual which was published on 2 Mar 69. The Manual provides a guide for all staff members in identifying staff areas of responsibility.
- (3) The most demanding analysis completed was the analysis of the I FFORCEV Tactical Operations Center (TOC). The Chief of Staff directed that CAP undertake this study to provide recommendations for more efficient TOC operations.
- (4) In conjunction with the analysis of the TOC, CAP prepared a prototype automatic data processing system for recording all Spot Report data which is reported to the TOC. This system is intended to assist in the analysis of friendly and enemy activities on the battlefield and in compiling statistical data. The system is presently being tested.
- (5) CAP undertook a study of the procedures, times, frequencies and content of I FFORCEV briefings. CAP recommended a new briefing routine which is presently being used in HQ, I FFORCEV.
- (6) Development of the Army Aviation Gunship Ordnance Expenditure Analysis System progressed during the period. Formats for computer printouts have been prepared and development of the computer program is nearing completion.
- (7) The Artillery Ammunition Analysis System was modified to include data on US Artillery Support for ARVN forces. CAP provided technical programming assistance to I FFORCEV Artillery for this modification.
- (8) CAP provided technical programming assistance to G3 Air for revision of the Tactical Air Expenditure Analysis System. The modifications resulted from a G3 Air study of utilization of the Analysis system by units in the field.
- (9) In conjunction with CORDS Office of Territorial Forces, CAP assisted in a study to determine ways to improve the Territorial Forces Evaluation System (TFES). The study centered on developing better methods of data presentation.
- (10) CAP prepared a study on reporting procedures for Incidents of VC Terrorism. This study was completed with the assistance of CORDS and G3 Operations and resulted in recommendations for more efficient reporting and accounting of VC Incidents against the civilian population.

UNCLASSIFIED

CONFIDENTIAL

AVFA-GC-07 15 May 1969
SUBJECT: Operational Report of Headquarters, 1 FFORCEV for Quarterly
Period Ending 30 April 1969, RCS CSFOR-65 (R1) (U)

2. SECTION 11 - LESSONS LEARNED: COMMANDERS OBSERVATIONS, EVALUATIONS AND RECOMMENDATIONS:

a. (U) PERSONNEL:

(1) Prevention of Malaria.

(a) OBSERVATION: The malaria chemoprophylaxis program must have command emphasis and be closely monitored by medical personnel.

(b) EVALUATION: When the urinary chloroquine test (determines if an individual has taken his chloroquine-primaquine tablet) is conducted on a unit with a high rate of malaria, results establish that a high percentage of the unit are not regularly taking the malaria tablet. Conclusions as to reason:

1. Those who depart Vietnam on h&R or leave neglect taking the malaria pill while they are out of country.

2. Personnel state a preference to "take their chances" rather than endure the discomforts of taking the pill, i.e., insomnia, nausea, diarrhea

3. A large number of individuals have the attitude "It can't happen to me", and neglect taking the malaria tablet. Nevertheless, if command emphasis is present and preventive medicine supervision is exercised, a higher percentage of the personnel can be induced into taking their tablet.

(c) RECOMMENDATION: That command emphasis be backed up by available preventive medicine programs and techniques as a further means of maintaining a good anti-malaria program.

b. (C) OPERATIONS:

(1) Anti-Guerrilla Propaganda and Extortion Tactics.

(a) OBSERVATION: VC propaganda and extortion teams often enter hamlets and villages on nights when the GVN forces are known to have withdrawn.

(b) EVALUATION: It is believed that the VC seize these opportunities not only to fulfill extortion goals, but also to reestablish the all important contact with and influence over the population. Occurrences have been noted when the normal defensive force has temporarily left a secure village after sweeps or cordon and searches. It is possible that the VC feel secure in these forays thinking that friendly forces will not return during the night. In a recent incident in Phu Yen Province, a well hidden ambush force remained while the main search force made an obvious withdrawal from a hamlet. The ambush netted three of the top VC in the area.

(c) RECOMMENDATION: Ruses employing stay-behind forces or obvious withdrawal and unobtrusive replacement of forces should be employed when combating VC teams.

(2) Personalized PSYOP Media.

(a) OBSERVATION: Psychological operators can increase the effectiveness of their PSYOP activities by the increased use of PSYOP media that contain messages tailored to fit a specific situation.

CONFIDENTIAL

CONFIDENTIAL

AVFA-CC-OT

15 May 1969

SUBJECT: Operational Report of Headquarters, 1 FFORCEV for Quarterly Period ending 30 April 1969, RCS CSFOR-65 (R1) (U)

(b) EVALUATION: Experience has shown that the use of PSYOP media depicting a general theme is very effective in gaining an initial impression on a given target. Additional PSYOP media can be directed toward subordinate targets among the main target which is being exposed to the primary medium. The media should be addressed to leaders and to members of a specific unit (Personalized PSYOP). This exploitation should take the form of a personal letter in leaflet form addressed to a leader or directed at the psychological vulnerabilities of a specific unit or a loudspeaker broadcast in the immediate area. Personalized information is contained in a target profile, which should be maintained by each psychological operator for each VC/NVA unit known to be operating in his area of responsibility.

(c) RECOMMENDATION: That the Personalized PSYOP media be used to the maximum possible extent to supplement general PSYOP media. Additionally, in order to utilize this type of PSYOP, recommend each psychological operator develop a target profile on the VC/NVA units known to be operating in their area of responsibility.

(3) Employment of PSDF Elements

(a) OBSERVATION: Numerous incidents reported throughout the II CTZ indicate VC terrorist campaigns are being concentrated on those villages and hamlets where PSDF elements have sole responsibility for the security. These attacks have been successful primarily because the Peoples Self Defense Forces have been unable to match the VC weaponry and experience. These attacks have not only netted the enemy food, money, weapons and other supplies and terrorized the populace in the villages and hamlets concerned, but have also succeeded in demoralizing many PSDF members to the point where they want to quit the program. On other occasions when their activities have been integrated into the overall security effort, the PSDF units have stood and fought courageously and assisted in repelling enemy attacks.

(b) EVALUATION: It is unrealistic to expect these inexperienced, para-military organizations with the present variety of weapons and equipment to compete successfully by themselves against experienced, hard core VC guerillas. Since the enemy will undoubtedly continue these type attacks against PSDF as long as he can continue achieving success with few casualties, PSDF activities must be integrated more closely with RF/PF defensive measures.

(c) RECOMMENDATIONS: PSDF should not be employed independently for the security of village/hamlet in areas where no immediate reaction assistance is available. Their activities must be integrated closely into the overall security plan, and specific defense responsibilities assigned them under the supervision and coordination of the village or hamlet chief. Only in close coordination with RF and PF operations will PSDF defense contributions be maximized.

(4) Tactical Unit Support of PHUNG HOANG Program.

(a) OBSERVATION: Tactical situation permitting, US ARVN and ROK tactical units have the personnel and material resources to assist in the achievement of pacification goals. To obtain their assistance in the PHUNG HOANG Program's attack against the VCI, all US combat battalions operating within II CTZ were briefed on the PHUNG HOANG Program of activities and insight into how they can aid and be aided by local

CONFIDENTIAL

CONFIDENTIAL

AVFA-GC-OT

15 May 1969

SUBJECT: Operational Report of Headquarters, I FFORCEV for Quarterly Period Ending 30 April 1969, RCS CSFOR-65 (R1) (U)

PHUNG HOANG organizations. Similar briefings were presented to ROKA personnel and are now being presented to ARVN units.

(b) EVALUATION: PHUNG HOANG briefings have significantly aided tactical unit comprehension of their role in the attack against the VC. This resulted in their noticeably enhanced support of the PHUNG HOANG Program.

(c) RECOMMENDATION: Where possible, briefings on PHUNG HOANG Program objectives should be presented to tactical units, in addition to written directives, in order to achieve maximum assistance and provide them with a thorough understanding of their pacification role.

(5) I FFORCEV Progress Analysis System.

(a) OBSERVATION: There is an increasing need at Corps level for more and better analysis of operational data to aid in evaluating and predicting enemy methods of operations, his strengths and his weaknesses, and in evaluating friendly progress in military, advisory and civil efforts.

(b) EVALUATION: Operational data was available in I FFORCEV Headquarters in the form of spot report information. However, it was not in a form that could be used for analysis without much manual processing. A computer program was developed which accepted this data which was extracted from spot reports and presented the data in a suitable format as information for analysis. The program can provide information of any of the parameters which constitute spot reports. It can also provide statistical information for reports to higher headquarters.

(c) RECOMMENDATION: That similar automated data processing system be considered for processing of operational data at Corps and similar headquarters.

(6) Employment of Persistent Agent (CS-2).

(a) OBSERVATION: Artillery often achieves only a marginal effect when attacking enemy sanctuaries where extensive bunker systems and fortifications have been constructed.

(b) EVALUATION: Persistent agent CS-2, dropped from CH-47 helicopters in 55 gallon drums, is effective in forcing the enemy from his fortifications. Once the area is covered by CS-2, an immediate artillery attack using both HE and FIRECRACKER Munitions will maximize enemy casualties. The CS-2 provides the added advantage of denying the enemy the unrestricted use of the area. Drums of CS-2 are issued with assembled burster and fuse, DODAC number is K766.

(c) RECOMMENDATION: That units consider this method of combined CS-2 and artillery employment when attacking a well entrenched, fortified enemy position.

(7) Vietnamese PSYOP Operations.

(a) OBSERVATION: Indigenous personnel should act as the primary face to face communicators during HE Team (Audio-Visual) operations; while the role of US personnel, assigned to HE teams, should be as advisors to Vietnamese PSYOP personnel.

CONFIDENTIAL

CONFIDENTIAL

AVFA-CC-OT

15 May 1969

SUBJECT: Operational Report of Headquarters, 1 FFORCEV for Quarterly Period Ending 30 April 1969, ACS CSFAM-65 (R1) (U)

(b) EVALUATION: The HE team is ideal for presenting propaganda on a person to person basis. The team is best utilized in conjunction with APT operations, Cultural Drama Team performances, during public gatherings etc. Team operations are more effective when the PSYOP effort is made by people who are familiar with the area, language and customs of the people. Furthermore, the use of indigenous personnel as primary communicators during operations enhances the image of GVN and does not give the impression of Americans conducting PSYOP against Vietnam. Each team should have the services of one VIS representative, two PSY / CA Team members and Armed Propaganda Team members in order to have facilities for conducting face to face operations.

(c) RECOMMENDATION: That indigenous personnel be used as the primary face to face communicators during HE team operations.

c. (U) TRAINING: None

d. (C) INTELLIGENCE:

62 (1) Importance of Segregating PW's:

(a) OBSERVATION: A number of incidents have occurred where a willing source lost his usefulness by acquiring self-confidence and effective cover stories from association with hard-core prisoners.

(b) EVALUATION: Hard-core communist PW's will fabricate cover stories for themselves and others. They will attempt to instill enough confidence in other PW's to resist the interrogator's efforts. This is done not only to deny information, but also to protect the captured cadre. When effective, the interrogator is deceived by the similarity of each prisoner's story and valuable time and information may be lost before discovering the conspiracy.

(c) RECOMMENDATION: Prisoners should be segregated both by rank and by willingness to cooperate. Interrogators should be alert for indications of cover stories and determine who the PW has associated with while in the cage.

64 (2) Confrontation of PW's as an Effective Interrogation Technique.

(a) OBSERVATION: Uncooperative PW's when confronted with a PW or HOI CHANH from the same unit, or of similar knowledge, often cease resisting interrogation.

(b) EVALUATION: The psychological impact of one PW believing that someone from his unit has "told all" and has been well treated is very effective in breaking his will to resist. In addition, information provided by one may assist in developing approaches to and questions for the other. In a recent incident, an available cooperative PW and an uncooperative PW from the same unit were both asked controlled questions. Upon hearing the former's answers, the latter became cooperative and provided valuable information. It is not necessary that one of the PW's be cooperative as long as the interrogator can give the impression that he has been a willing source.

(c) RECOMMENDATION: Whenever possible, a PW should be confronted

CONFIDENTIAL

CONFIDENTIAL

AV: A-GC-OT

15 May 1969

SUBJECT: Operational Report of Headquarters, I FFORCEV for Quarterly
Period Ending 30 April 1969, RCS CSFOR 65 (R1) (U)

by a member of his unit. The whereabouts of PW's from a given unit should be recorded and kept current to facilitate recall for confrontation purposes.

(3) Artillery Air Advisories.

(a) OBSERVATION: When Artillery Warning Control Centers (AWCC) post air advisories, the maximum ordinate of the trajectory, general point of impact and the time of firing are disclosed.

(b) EVALUATION: The AWCC performs a vital function in aircraft safety; however, valuable intelligence often is given to the enemy through the air advisory broadcast. AWCCs should use a more secure means of directing aircraft around hazardous areas by making reference to terrain features, e.g., "Stay east of the Dak Poko River and north of Highway 19". If adequate terrain features are not available, an aircraft could be diverted by means of grid lines, e.g., "Stay south of east-west 80 line and west of north-south 20 line".

(c) RECOMMENDATION: That AWCCs consider the above method of posting air advisories in the interest of security.

e. (U) LOGISTICS

Ex
(1) Bunker Construction.

(a) OBSERVATION: During VC attacks on hamlets, many civilian casualties are caused, not by gunfire, but by suffocation when civilians take refuge in bunkers.

(b) EVALUATION: The village of Kon Horing, Kontum Province, was attacked by VC forces 23 - 26 February 1969. Many of the civilians took cover in bunkers constructed under their houses. The enemy force set fire to portions of the village during the initial hours of contact causing numerous dwellings to burn to the ground and collapse in flames on top of the bunkers. A total of 52 civilians were killed, the great preponderance of them as a result of suffocation in the unventilated bunkers. An investigation of the incident revealed that none of the bunkers had air vents, escape exits, or good overhead cover and all of the bunkers had been constructed beneath surface dwellings. The lessons learned from these observations are not new nor are they unique to the civilian Vietnamese and Montagnards discussed. U.S. Army doctrine advocates building bunkers with overhead protection and outlines the necessary action to prevent or reduce the impact of grenades, mines and satchel charges. A simple change-of-direction tunnel (air ventilation system) is required regardless of the location of the bunker. It is imperative that the advisory personnel constantly monitor the construction and location of bunkers within their sphere of influence.

(c) RECOMMENDATION: Bunkers should be constructed outside of buildings and should have overhead cover, adequate air tunnels and an exit tunnel for escape. One bunker entrance should be located inside the house.

f. ORGANIZATION: None

g. (C) OTHER.

(1) Planning of Civic Action Projects.

CONFIDENTIAL

CONFIDENTIAL

AVFA-3C-07

15 May 1969

SUBJECT: Operational Report of Headquarters, I FFORCEV for Quarterly Period Ending 30 April 1969 RCS CSFOR-65 (R1) (U)

(a) OBSERVATION: Frequently, well meaning groups will undertake civic action projects without coordination with responsible GVN officials or without the capability of completing the project.

(b) EVALUATION: Recently, a US civic action team constructed several classrooms within their TAOR and recruited teachers who were paid by the unit's Chaplain Fund. However after the project had been initiated, the unit discovered that they were not able to finance the teachers salaries. The Province Education Service Chief was contacted and agreed to work with the unit towards finding a satisfactory solution to the problem. A similar problem has been frequently encountered with the employment of MEDCAP teams. A MEDCAP team is employed into a village and hamlet but does not have the capability of treating all patients and does not conduct follow visits.

(c) RECOMMENDATION: In the planning of all civic action projects, US units should insure that they have the capability of completing the project and that responsible GVN agencies are coordinated with.

(2) Trilingual Publication of Directives and Reference Material.

(a) OBSERVATION: The GVN, through the PHUNG HOANG Program, have the primary responsibility for attacking the VCI. The US provides advisory assistance to the PHUNG HOANG Program by placement of PHUNG HOANG coordinators at all echelons. Most PHUNG HOANG directives and reference material therefore, have been published in English and Vietnamese. The ROKs, however, have an action capability against the VCI as do the US and ARVN combat units. Virtually no PHUNG HOANG directives or reference material, however, have been printed in Korean, though PHOENIX Staff, Saigon is now resolving this deficiency.

(b) EVALUATION: Lack of available Korean versions of PHUNG HOANG reference material have precluded ROK agencies from possessing a thorough understanding of the PHUNG HOANG Program and its objectives.

(c) RECOMMENDATION: In those cases where third country units and agencies have an action requirement or capability to provide assistance to the pacification effort, pertinent directives and reference material should be trilingually published (Vietnamese, English and third country language) and simultaneously disseminated through respective channels.

(3) Monthly Military Support of Pacification Meeting.

(a) OBSERVATION: The monthly meetings sponsored by the province chiefs for senior tactical commanders operating within the province can be an effective means of coordinating the military support of pacification.

(b) EVALUATION: In Jan 69, CG, II CTZ directed that the province chiefs sponsor a monthly meeting for all tactical commanders operating in the province. The purpose is to update these commanders on pacification and solicit their support and cooperation. The combined commanders in II CTZ affirmed their unanimous support for this approach to uniting the military and civil effort by publishing a combined letter on the Military Support of Pacification. This letter directed all commanders to support, where possible requests for assistance made by the province chief at the monthly meeting. After action reports of the meetings held to date have varied in the degree of results achieved. There is a clear indication, however, that with the continued emphasis of the combined commanders in II CTZ, that the province monthly meetings will provide the basis for a close and harmonious integration of the military with the pacification effort.

CONFIDENTIAL

CONFIDENTIAL

AVFA-GC-OT

15 May 1969

SUBJECT: Operational Report of Headquarters, I FFORCEV for Quarterly
Period Ending 30 April 1969, RCS CSFOR-65 (R1) (U)

(c) RECOMMENDATION: That the above requirement for monthly meetings sponsored by the province chief for tactical commanders be studied with a view toward adopting it in other corps tactical zones.

FOR THE COMMANDER:

S. P. Rogers
S. P. ROGERS

Colonel, GS
Deputy Chief of Staff

DISTRIBUTION:

- 2 - DA, ACSFOR
- 2 - CINCUSARPAC
- 5 - CG, USARV
- 2 - CG, II FFORCEV
ATTN: AVFBC-RE-H
- 1 - CG, 4th Inf Div
- 1 - CG, 173d Abn Bde (Sep)
- 1 - CG, I FFORCEV Arty
- 1 - CO, Task Force South (Prov)
- 1 - DSA, II Corps
- 1 - ACoS, G1
- 1 - ACoS, G2
- 4 - ACoS, G3
- 1 - ACoS, G4
- 1 - US Army War College, ATTN: Library Q-2149
- 1 - Comdt, USA C&GSC, Ft Leavenworth
- 2 - 13th Mil Hist Det
- 1 - CORDS
- 1 - Comdt, USAIS, Ft Benning, Ga 31905
- 1 - USACDC LNO

CONFIDENTIAL
91

CONFIDENTIAL

AVHGC-DST (15 May 1969) 1st Ind
SUBJECT: Operational Report of Headquarters, I FFORCEV for Period
Ending 30 April 1969, RCS CSFOR-65 (R1) (U)

HEADQUARTERS, UNITED STATES ARMY, VIETNAM, APO San Francisco 963751 1 JUN 1969

TO: Commander in Chief, United States Army, Pacific, ATTN: GPOP-DT,
APO 96558

Assistant Chief of Staff for Force Development, Department of the
Army, Washington, D.C. 20310

1. (U) This headquarters has reviewed the Operational Report-Lessons Learned for the quarterly period ending 30 April 1969 from Headquarters, I FFORCEV.

2. (C) Comments follow:

a. (U) Reference item concerning Prevention of Malaria, section II, page 85, paragraph 2a(1); concur. The current preventive medicine program in malaria prevention includes all aspects of malaria prevention in addition to malaria chemoprophylaxis. The key to a successful malaria prevention program is command emphasis in the form of supervision, and enforcement surveillance of the program at all levels of responsibility. In regard to malaria chemoprophylaxis, it is the responsibility of medical personnel to insure that the drugs are available to command; however, it is the responsibility of command to insure that the individual takes the drugs. Strong continuous command emphasis must be placed upon currently recommended malaria preventive measures in order to maintain an effective unit malaria prevention program.

b. (U) Reference item concerning Personalized PSYOP Media, section II, page 85, paragraph 2b(2); concur. The selection and exploitation of significant target groups is a critical aspect of PSYOP. One of the functions of PSYOP intelligence is to locate, identify, and analyze target group attitudes and susceptibility. These points are recognized in FM 33-5, paragraph 11 and 12. This recommendation will be brought to the attention of the 4th PSYOP Group for information and necessary action.

c. (U) Reference item concerning I FFORCE V Progress Analysis System, section II, page 87, paragraph 2b(5). Concur with recommendation that all Corps and similar headquarters study the feasibility of processing operational intelligence data by means of the Automated Data Processing System (ADPS). Not only can valuable time be gained as a result of the quick response capability of ADPS vis-a-vis manual processing, but as indicated in reference item, operational data can be displayed in a more readily usable form. This item will be published in the Intelligence Newsletter.

CONFIDENTIAL

72

DOWNGRADED AT 3 YEAR INTERVALS;
DECLASSIFIED AFTER 12 YEARS.
DOD DIR 5200.10

CONFIDENTIAL

AVHGC-DST (15 May 1969) 1st Ind

SUBJECT: Operational Report of Headquarters, I FFORCEV for Period
Ending 30 April 1969, RCS CSFOR-65 (R1) (U)

d. (U) Reference item concerning Employment of Persistent Agent (CS-2), section II, page 87, paragraph 2b(6). Concur with recommendation that persistent agent (CS-2) be used in conjunction with artillery fires when attacking well entrenched, fortified enemy positions. Information concerning this method of employing chemical agents was disseminated to chemical officers of all major USARV subordinate units during the USARV chemical conference, held 27 January 1969.

e. (U) Reference item concerning Vietnamese PSYOP, section II, page 88, paragraph 2d(1); concur. The benefits of employing indigenous personnel are recognized in FM 33-5, paragraph 79. Their employment as announcers in loudspeaker operations takes advantage of their idiomatic, unaccented language fluency. The benefits of employing Vietnamese Information Service (VIS) representatives are widely recognized as they represent a civilian agency in addition to being native Vietnamese. The recommendation will be brought to the attention of 4th PSYOP Group for information and necessary action.

f. (C) Reference item concerning Artillery Air Advisories, section II, page 89, paragraph 2d(3); concur. MACV Directive 95-13, 24 February 1968, is presently being reviewed to consider operational security requirements concurrently with other requirements of the artillery air warning system.

g. (U) Reference item concerning Bunker Construction, section II, page 89, paragraph 2e(1); concur. Standard bunkers constructed by both engineer brigades, and by contractors, are designed for construction outside of buildings, have overhead cover, provide for adequate air and a means for entrance and egress. Advisory personnel should constantly monitor the construction and location of bunkers within their sphere of influence. Unit will be advised of above comment.

h. (U) Reference item concerning Civic Action Projects, section II, page 89 - 90, paragraph 2g(1); concur. The need to insure that civic action projects can be completed and that they are coordinated with GVN agencies and MACCORDS advisors has been repeatedly stressed in civil affairs conferences. Guidance for conducting civic action projects has been published in USARV Regulation 515-1. A restatement of policy will be included in a future issue of the USARV G5 Newsletter.

i. (U) Reference item concerning the 1969 Pacification Program, section II, page 90, paragraph g(1); concur. Close coordination between Vietnamese province chiefs and senior US tactical commanders is recognized as the most effective means for coordinating US support for pacification

CONFIDENTIAL

CONFIDENTIAL

AVHGC-DST (15 May 1969) 1st Ind
SUBJECT: Operational Report of Headquarters, I FFORCEV for Period
Ending 30 April 1969, RCS CSFOR-65 (R1) (U)

and has been established in the Combined Campaign Plan. The substance of the recommendation will be included in recommendations forwarded to MACV for consideration. No further action required by higher headquarters.

FOR THE COMMANDER:



C. D. WILSON
LTJ. AGC
Assistant Adjutant General

Cy furn:
IFFV

CONFIDENTIAL

GPOP-DT (15 May 1969) 2d Ind (U)
SUBJECT: Operational Report of HQ, I FFORCEV for Period Ending
30 April 1969, RCS CSFOR-65 (R1)

HQ, US Army, Pacific, APO San Francisco 96558 **22 JUL 69**

TO: Assistant Chief of Staff for Force Development, Department of the
Army, Washington, D. C. 20310

This headquarters has evaluated subject report and forwarding indorse-
ment and concurs in the report as indorsed.

FOR THE COMMANDER IN CHIEF:

C. L. Shortt
C. L. SHORTT
CPT, AGC
A-1 AG

CONFIDENTIAL

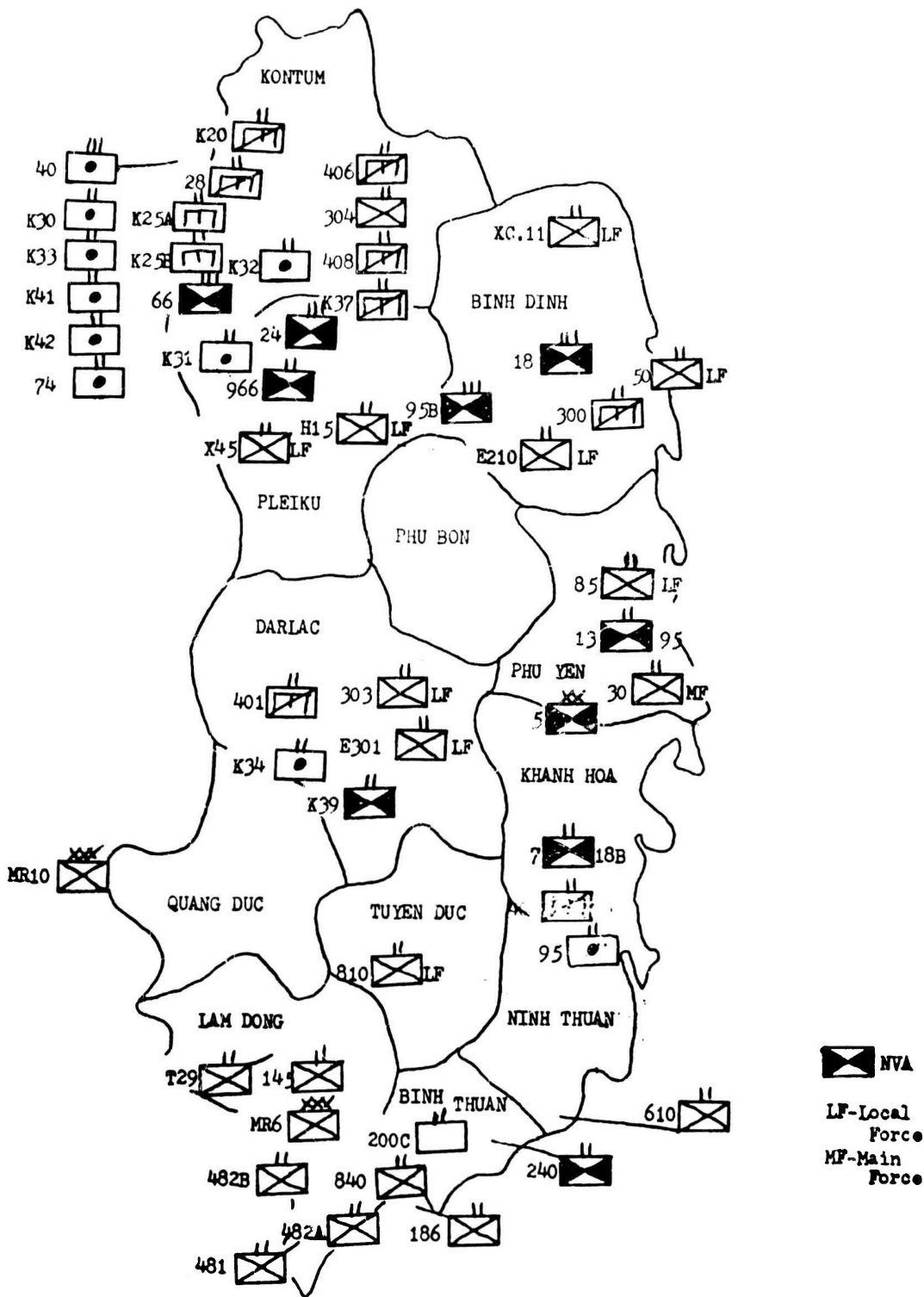

DOWNGRADED AT 3 YEAR INTERVALS;
DECLASSIFIED AFTER 12 YEARS.
DOD DIR 5200.10

CONFIDENTIAL

II CTZ MAJOR ROAD NET & AIRFIELDS

20 JANUARY 1969

LEGEND

C-130	●	OPEN	○
C-123	●	CLOSED	○
C-7A	▲		▲
ABANDONED AIRFIELD	○		○
LIGHT AIRCRAFT AIRFIELD	○		○
MAJOR HELIPORT	○		○
MAJOR S. AIRPORT	○		○
(24 FT WIDE, 8 FOOT SHOULDERS, CL 50 ONE WAY, CL 35 TWO WAY)	—		—
CLASS 31 ROAD	—		—
CLASS 10 ROAD	—		—
CLASS 5 ROAD	—		—
STATUS OF ROAD NOT KNOWN OR CLOSED	—		—
NATIONAL ROUTES	○	(N)	○
INTERPROVINCIAL ROUTES	○	(I)	○
PROVINCIAL ROUTES	○	(P)	○
SUPPLEMENTARY ROUTES	○	(S)	○
COMMUNAL ROUTES	○	(C)	○
INTERNATIONAL BOUNDARY	—		—
PROVINCE BOUNDARY	—		—
PROVINCE NAME	PLEIKU		

Notes:
 1. For detailed information see: (a) 1:50,000 Scale Map of South Vietnam (1:50,000 Scale Map of South Vietnam)
 (b) 1:250,000 Scale Map of South Vietnam (1:250,000 Scale Map of South Vietnam)
 (c) 1:500,000 Scale Map of South Vietnam (1:500,000 Scale Map of South Vietnam)
 (d) 1:1,000,000 Scale Map of South Vietnam (1:1,000,000 Scale Map of South Vietnam)
 (e) 1:2,000,000 Scale Map of South Vietnam (1:2,000,000 Scale Map of South Vietnam)
 (f) 1:5,000,000 Scale Map of South Vietnam (1:5,000,000 Scale Map of South Vietnam)
 (g) 1:10,000,000 Scale Map of South Vietnam (1:10,000,000 Scale Map of South Vietnam)
 (h) 1:20,000,000 Scale Map of South Vietnam (1:20,000,000 Scale Map of South Vietnam)
 (i) 1:50,000,000 Scale Map of South Vietnam (1:50,000,000 Scale Map of South Vietnam)
 (j) 1:100,000,000 Scale Map of South Vietnam (1:100,000,000 Scale Map of South Vietnam)

1. Road by sea route from Ho Chi Minh City to Pleiku
2. Road by sea route from Ho Chi Minh City to Pleiku
3. Road by sea route from Ho Chi Minh City to Pleiku
4. Road by sea route from Ho Chi Minh City to Pleiku
5. Road by sea route from Ho Chi Minh City to Pleiku

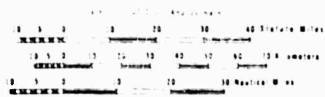

- 1.0 HINH (D. 11.5) 173d Abn Div
- 2.0 HINH (D. 11.5) 173d Abn Div
- 3.0 HINH (D. 11.5) 173d Abn Div
- 4.0 HINH (D. 11.5) 173d Abn Div
- 5.0 HINH (D. 11.5) 173d Abn Div

CONFIDENTIAL

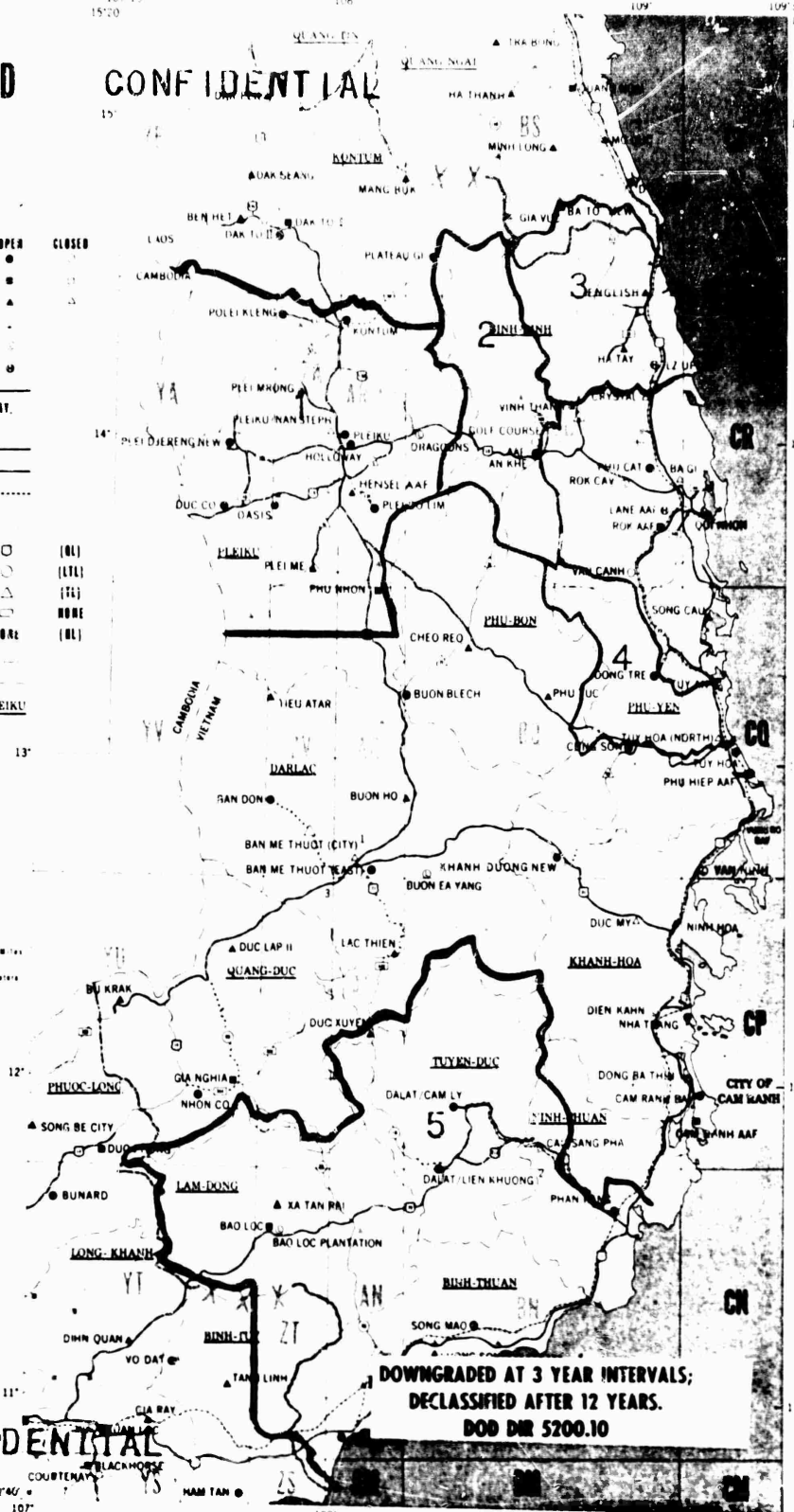

DOWNGRADED AT 3 YEAR INTERVALS;
 DECLASSIFIED AFTER 12 YEARS.
 DOD DIR 5200.10

COMPILED BY 1 FORCE CV (1000000000)
 DRAFTED BY 1000000000 (1000000000)

CONFIDENTIAL

CONFIDENTIAL

HEADQUARTERS I FFORCEV TASK ORGANIZATION

AS OF 30 APR 1969

ASSIGNED UNITS	AUTHORITY	STATUS	ALLOCATION	DATE	INITIALS
HHC, I FFORCEV	USARV GO 668, 20 Sep 65	Attached HQ I FFORCEV Arty	I FFORCEV GO	234, 25 Apr 69	MB
HQB, I FFORCEV Arty	USARV GO 1783, 20 Dec 65	Attached HQ I FFORCEV Arty	I FFORCEV GO	374, 9 May 67	MB
I FFORCEV Prov Arty Gp	I FFORCEV GO 192, 5 Apr 69	Attached HQ I FFORCEV Arty	I FFORCEV GO	391, 9 Oct 66	FAC
41st Arty Group	USARV GO 2077, 6 May 67	Attached HQ I FFORCEV Arty	I FFORCEV GO	151, 24 Feb 68	AKL
52d Arty Group	USARV GO 57, 5 Jan 67	Attached HQ I FFORCEV Arty	I FFORCEV GO	30, 20 Jan 68	BMT
4th Bn (AW) (SP) 60th Arty	USARV GO 1195, 18 Mar 67	Attached HQ I FFORCEV Arty	I FFORCEV GO	129, 16 Feb 68	FAC
5th Bn (8"/175mm) (SP) 22d Arty	USARV GO 6496, 18 Dec 67	Attached HQ I FFORCEV Arty	I FFORCEV GO	129, 16 Feb 68	TYH
5th Bn (105mm) (T) 27th Arty	USARV GO 1762, 30 Nov 65	Attached HQ I FFORCEV Arty	I FFORCEV GO	311, 2 Apr 68	ANE
6th Bn (8"/175mm) (SP) 32d Arty	USARV GO 1417, 29 Mar 67	Attached HQ I FFORCEV Arty	I FFORCEV GO	151, 24 Feb 68	AKL
6th Bn (155mm) (T) 84th Arty	USARV GO 1126, 15 Mar 68	Attached HQ I FFORCEV Arty	I FFORCEV GO	151, 24 Feb 68	AKL
HQB, 8th Bn (TA) 26th Arty	USARV GO 361, 25 Jan 67	Attached HQ I FFORCEV Arty	I FFORCEV GO	151, 24 Feb 68	AKL
Btry B, 29th Arty (SCHLT)	USARV GO 1195, 18 Mar 67	Attached HQ I FFORCEV Arty	I FFORCEV GO	129, 16 Feb 68	FAC
77th FA Det (Radar)	USARV GO 1913, 28 Mar 66	Attached HQ I FFORCEV Arty	I FFORCEV GO	129, 16 Feb 68	FAC
237th FA Det (Radar)	USARV GO 1913, 28 Mar 66	Attached HQ I FFORCEV Arty	I FFORCEV GO	1, 5 Jan 68	AKL
241st FA Det (Radar)	USARV GO 5791, 10 Nov 67	Attached HQ I FFORCEV Arty	I FFORCEV GO	1, 5 Jan 68	FAC
242d FA Det (Radar)	USARV GO 5791, 10 Nov 67	Attached HQ I FFORCEV Arty	I FFORCEV GO	1, 5 Jan 68	FAC
243d FA Det (Radar)	USARV GO 5791, 10 Nov 67	Attached HQ I FFORCEV Arty	I FFORCEV GO	1, 5 Jan 68	FAC
244th FA Det (Radar)	USARV GO 5791, 10 Nov 67	Attached HQ I FFORCEV Arty	I FFORCEV GO	1, 5 Jan 68	FAC
253d FA Det (Radar)	USARV GO 5791, 10 Nov 67	Attached HQ I FFORCEV Arty	I FFORCEV GO	724, 19 Sep 68	BMT
254th FA Det (Radar)	USARV GO 2511, 27 May 68	Attached HQ I FFORCEV Arty	I FFORCEV GO	724, 19 Sep 68	FSE 12
255th FA Det (Radar)	USARV GO 2511, 27 May 68	Attached HQ I FFORCEV Arty	I FFORCEV GO	724, 19 Sep 68	AKL
256th FA Det (Radar)	USARV GO 2932, 20 Jun 68	Attached HQ I FFORCEV Arty	I FFORCEV GO	724, 19 Sep 68	ENR

Incl 3

PAGE 1 OF 4 PAGES

DOWNGRADED AT 3 YEAR INTERVALS;
DECLASSIFIED AFTER 12 YEARS.
DOD DIR 5700.10

CONFIDENTIAL

CONFIDENTIAL

ASSIGNED UNITS	AUTHORITY	STATUS	AUTHORITY	LOC
2d Bn (105mm) (T) 17th Arty	USARV GO 57, 5 Jan 67	Attached 41st Arty Group	I FFORCEV GO 805, 13 Oct 67	AKE
7th Bn (105mm) (T) 13th Arty	USARV GO 6208, 31 Oct 66	Attached 41st Arty Group	I FFORCEV GO 391, 9 May 67	PHC
7th Bn (8"/175mm) (SP) 15th Arty	USARV GO 3467, 9 Jul 67	Attached 41st Arty Group	I FFORCEV GO 576, 19 Jul 67	PHC
1st Bn (155mm) (T) 92d Arty	USARV GO 1195, 18 Mar 67	Attached 52d Arty Group	I FFORCEV GO 334, 11 Apr 67	PKU
3d Bn (105mm) (SP) 6th Arty	USARV GO 57, 5 Jan 67	Attached 52d Arty Group	I FFORCEV GO 287, 29 Jul 66	PKU
6th Bn (8"/175mm) (SP) 14th Arty	USARV GO 1205, 26 Oct 65	Attached 52d Arty Group	I FFORCEV GO 287, 29 Jul 66	PKU
2d Armd Sqdn, 1st Cav	USARV GO 5028, 2 Oct 67	Attached 4th Inf Div	USARV GO 4445, 20 Sep 68	SDI
1st Bn (Mech) 50th Inf	USARV GO 5381, 22 Oct 67	Attached 173d Abn Bde (Sep)	USARV GO 4445, 20 Sep 68	LZ UPLIFT
Co C (Ranger) 7th Inf	USARV GO 542, 16 Feb 69	Attached 173d Abn Bde (Sep)	USARV GO 542, 16 Feb 69	AKE
54th Inf Det (RADAR)	USARV GO 3137, 27 May 66	Attached 4th Inf Div	I FFORCEV GO 204, 11 Apr 69	AKE
68th Inf Det (RADAR)	USARV GO 1913, 28 Mar 66	Attached 52d CAB	I FFORCEV GO 415, 25 Oct 66	PKU
1st Cal Det (CBEC)	USARV GO 1023, 24 Mar 69			PNT
5th PI Det	USARV GO 640, 12 Feb 68			NHA
11th PI Det	USARV GO 640, 12 Feb 68			NHA
13th Mill Hist Det	USARV GO 526, 5 Feb 68			NHA
32d CS Chap Det	USARV GO 542, 16 Feb 69			PKU
41st CA Co (-)	USARV GO 3434, 17 Jul 68			NHA
54th Sig Bn (Corps)	USARV GO 640, 12 Feb 68			NHA
55th KI Det	USARV GO 1229, 27 Oct 65			NHA
64th Engr Det (Terrain)	USARV GO 159, 12 Jan 66			NHA
167th Sig Co (RR)	USARV GO 640, 12 Feb 68	Attached 54th Sig Bn	I FFORCEV GO 147, 22 Feb 68	PKU
209th Sig Det (LA)	USARV GO 1590, 15 Nov 65	Attached 54th Sig Bn	I FFORCEV GO 25, 16 Nov 65	NHA
272d MP Co (Corps)	USARV GO 640, 12 Feb 68			NHA
297th Trans Co (CAR)	USARV GO 5953, 6 Oct 66			NHA
Camp Radcliff Augmentation				
Security Det (Prov)	USARV GO 1592, 5 May 69	Attached 4th Inf Div	USARV GO 1592, 5 May 69	AKE
HQ, Task Force South (Prov)	I FFORCEV GO 604, 24 Jul 68			DLT

Incl 3

PAGE 2 OF 4 PAGES

CONFIDENTIAL

CONFIDENTIAL

HEADQUARTERS I FORCE V TASK ORGANIZATION

<u>OPCON UNITS</u>	<u>AUTHORITY</u>	<u>LOC</u>
4th Inf Div	USARV OPLAN 78-66 (OP ROBLIN) MACV msg (S) MACCOC12 05002, 171835Z Feb 68, Unit Deployment (U)	EMARI
173d Abn Bde (Sep)	MACV msg (S) MACCOC11 16892, 231133Z May 67, Reinforcement of II CTZ (U)	EGH
II Corps US Army Advisory Gp	MACV LOI 1-66 dtd 29 Mar 66 paragraph 5(3)	PKU
17th Combat Aviation Gp	MACV LOI 1-66 dtd 29 Mar 66 Task Organization	NHA
7th Sqdn, 17th Air Cav	USARV msg (C) AVHGC O 31527 110846Z Jan 68 Assignment Status of 201st Avn Co (Corps) and 7/17th Air Cav Sqdn (U)	EMARI
3d Bn (AM) 506th Inf (1st Bde, 101st Abn Div (AM))	MACV msg (S) MACCOC11 01493, 151110Z Jan 68 Byrd AO (U)	PHT
8th PSYOPS Bn	MACV ltr (FOUO) MACPD dtd 6 Dec 66, Employment of the US Army 6th PSYOPS Battalion (Tactical)	NHA
Co B, 5th SFG	MACV LOI 1-66 dtd 19 Mar 66 paragraph 5 (4) MACV msg (S) MACCOC12 02553, 211235Z Jan 67, OPCON of USASF Team in II CTZ (U)	PKU
201st Avn Co (Corps)	USARV msg (C) AVHGC-O 31527, 110846Z Jan 68, Assignment Status of 201st Avn Co (Corps) and 7/17th Air Cav Sqdn (U)	NHA
313th RR Bn	HQ Army Security Agency GO 47, 6 Jun 68	NHA

PAGE 3 OF 4 PAGES

Incl 3

CONFIDENTIAL

CONFIDENTIAL

AVIATION SUPPORT

THE FOLLOWING AVIATION UNITS
(CURRENTLY ASSIGNED TO THE 17TH AVIATION GROUP)
SUPPORT HEADQUARTERS I FIELD FORCE VIETNAM

10th Cbt Avn Bn

48th AHC
92d AHC
155th AHC
192d AHC
281st AHC
281st AHC
243d ASHC

52d Cbt Avn Bn

57th AHC
119th AHC
170th AHC
189th AHC
361st AWC
179th ASHC

101

223 Cbt Spt Avn Bn

18th UAC
183d RAC
185th RAC
203d RAC
219th RAC
225th SAC

* OPCON to SA, IV Corps

Incl 3

268th Cbt Avn Bn

61st AHC
129th AHC
134th AHC
*335th AHC
180th ASHC
196th ASHC
355th Hel Co (Hvy)
238th AWC

PAGE 4 OF 4 PAGES

CONFIDENTIAL

CONFIDENTIAL

COMMAND RELATIONSHIP

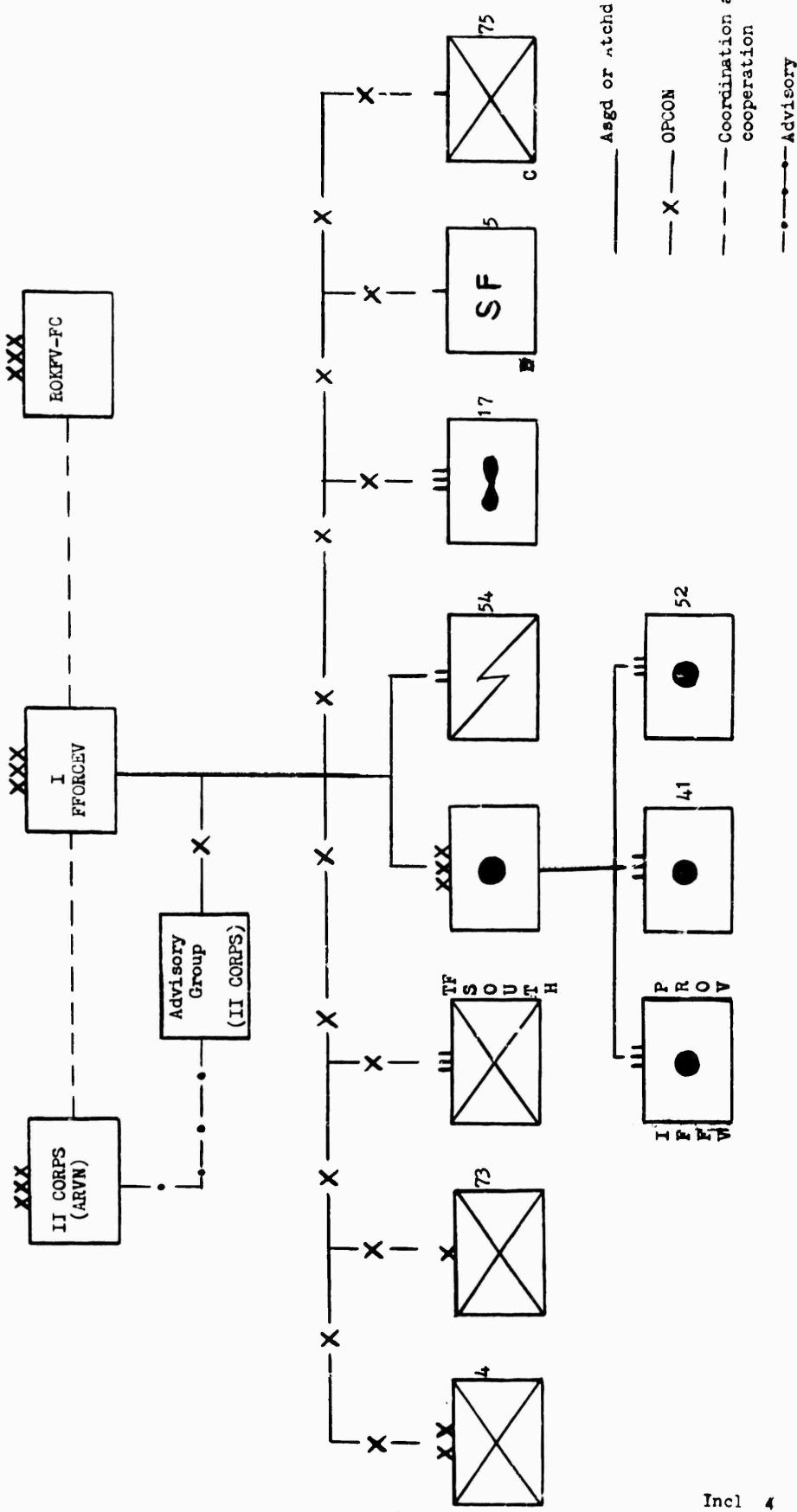

CONFIDENTIAL

DOWNGRADED AT 3 YEAR INTERVALS;
DECLASSIFIED AFTER 12 YEARS.
DOD DIR 5700.10

CONFIDENTIAL
**TACTICAL
NOTES**



I FIELD FORCE VIETNAM

IN THIS ISSUE



- * AIR LOADING OF HOWITZERS.
- * MARKING OF LANDING ZONES DURING COMBAT ASSAULT.
- * ENEMY MINING OF AIRFIELDS.
- * AVOID A COUNTERAMBUSH.
- * PUTTING LZ PERIMETER DEFENSE ASSETS TO WORK.
- * ENEMY ROAD AMBUSH TACTICS.

FEBRUARY 1969

DOWNGRADED AT 3 YEAR INTERVALS;
DECLASSIFIED AFTER 12 YEARS.
DOD DIR 5200.10

Incl 5

103
CONFIDENTIAL

TACTICAL NOTES

VOL 2 NO 2

I F FORCE V

PURPOSE

In producing TACTICAL NOTES, I F FORCEV Headquarters compiles and highlights in each edition those insights gained from battle -- insights old, insights new -- in order that the reader may have the opportunity to study them; put them to his own use where appropriate; and pass them along to others as a contribution to the military art. If TACTICAL NOTES accomplishes at least a part of this, it will have served well the purpose for which the publication was designed.

Up to date, helpful hints, valuable at all levels of command, is the end sought by these notes. Contributions from commanders of all assigned and OPCON units, as well as other organizations receiving the NOTES, including advisors with ARVN units and liaison officers with ROK units, are highly desired and solicited.

It is suggested that each commander carry in his pocket a number of 3 X 5 index cards so that, when an idea occurs to him which might be appropriate for inclusion in TACTICAL NOTES, he might jot it down for later drafting. Pertinent details of "tactical lessons learned" should be recorded as they happen. In this way current and concise details can be preserved. All contributions submitted for inclusion in TACTICAL NOTES should reach this headquarters by the fifteenth of each month.

FOR THE COMMANDER:

Arthur B. Busbey, Jr.
ARTHUR B. BUSBEY, JR.
Colonel, AGC
Adjutant General

DISTRIBUTION:
H

C O N T E N T S

ARTILLERY TECHNIQUES

Airloading of 105mm Howitzers	6
Defense with BEEHIVE	6
Artillery Employment with the Night Observation Device	7
Observer Shifts using FADAC	7
Collimator Adjustment	8
The Double Check System	8

PACIFICATION POINTERS

Consolidated Village Defense	9-10
Integration of PSYOP with MEDCAP Operation	10
Regularly Scheduled MEDCAP Missions	11
Quick Rebuild	11
Reduction of Desertions Among RD Cadre	12

AIRCRAFT SECURITY

Enemy Mining of Airfields	13
-------------------------------------	----

MAINTAINING MORALE

The "Pill".	14
Recovery of Personnel MIA	14
Expediting Awards	15

TALKING TO OTHERS

Working Together 16-18

COVER YOUR HEAD

Overhead Cover for RF/PF Installations . . . 19

A SUCCESSFUL AMBUSH

You Versus Charlie 20

ACCURATE COUNTING

Ground Confirmation of FAC Reporting KBA . . . 21

BETTER USE OF PERIMETER FORCES

Putting LZ Perimeter Defense Assets to Work . 22-23

HOW TO HEAR AND SEE CHARLIE

Early Warning for RF/PF Operating Bases . . . 24-25

FINDING THE ENEMY

Scorpion Operations 26

OPERATIONS: HELPFUL TACTICAL HINTS

Enemy Road Ambush Tactics 27

Marking of Landing Zones During Combat	27-28
Assault	
Tunnel/Cave Operations	28
Use of Aerial Loud Speakers in Cordon and . .	28
Search Operations	
Cordon-Search Innovation or "Charlie Gets . .	29
Hungry and Thirsty, Too."	

HOW TO OBTAIN INFORMATION ON THE ENEMY

Volunteer Information Program	30
---	----

BE ALERT TO VC TERRORISTS THEY STRIKE AT WEAKNESSES

Terrorist Tactics in Urban Areas	31-32
--	-------

ARTILLERY TECHNIQUES

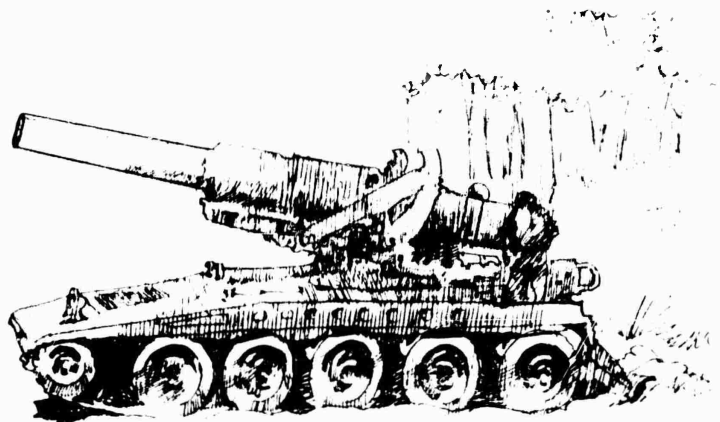

(U) Airloading of 105mm Howitzers. Batteries of M102 Howitzers must often move by C-130 aircraft in an extremely short period of time. A simple modification to the 3/4 ton prime mover - moving the howitzer hitch from the rear to the front bumper - greatly expedites aircraft loading. Because of the much greater control over the howitzer, as compared with previous attempts to back it in with the truck, loading time of the battery can be cut in half. Only one prime mover per battery need be modified to achieve this. 173d Abn Bde

(U) Defense with BEEHIVE. For the most effective employment of BEEHIVE, 105mm shell M546, howitzers should be deployed in an elliptical pattern with interlocking zones of fire. Automatic weapons should be weighted on the narrow ends of the ellipse as shown in the diagram at Appendix I. Secondary gun positions should be selected so that firepower can be massed on any given area. To minimize deadspace and loss of coverage, the minimum elevation of the piece should be considered in the selection of each position. With proper protection from the rear, the defenders on the perimeter may remain in front of the pieces; however, a clearly understood signal must be arranged to alert all personnel when BEEHIVE is to be fired.

I FORCEV Artillery

(U) Artillery Employment with the Night Observation Device. The Night Observation Device, Medium Range, can accurately detect personnel at ranges in excess of 4,000 meters during the hours of darkness. When exposed to bright flashes such as bursting artillery rounds, the device will blank or "white out" for a 20 second period interrupting continuous observation of the target. Therefore the Night Observation Device should be used for target acquisition and not for adjustment of artillery fire. When attacking a target with artillery during the hours of darkness a BC scope or binoculars should be used to sense rounds while surveillance between adjustments is maintained with the Night Observation Device.

I FFORCEV Artillery

(U) Observer Shifts using FADAC. An error or observer correction to a shift detected after the compute mode has terminated cannot be corrected as described in FM 6-3-1. The procedure in the FM is valid only if the compute mode has not been completed. To correct a shift after it has been computed by the FADAC, it is necessary to compute an equal and opposite shift prior to entering the observer's desired shift. A caution note concerning this method should be added to paragraph 2-10e, FM 6-3-1.

I FFORCEV Artillery

(U) Collimator Adjustment. When the collimator used with the M108 or M109 howitzer cannot be placed at a sufficient distance from the panoramic telescope, certain large deflection changes may cause the turret to block the line of sight. The problem may be solved by setting the standard legs of the collimator into one inch pipe lengths which are long enough to raise the height of the collimator to that of the sight. The collimator then may be placed at any convenient distance from the howitzer without interruption of 6400 mil capability.

I FFORCEV Artillery

(U) The Double Check System. Recent artillery incidents have once again pointed to the importance of the double check system. All data computed in the FDC must be checked by an independent source. The principal chart operator should have a back up chart and the chief computer should be checked by another member of the FDC and by the Fire Direction Officer. The executive officer should check FDC's data before it is placed on the guns, particularly when large changes in deflection and quadrant occur. When FADAC is available at both battalion and battery, battalion should check the battery's data. If only one FADAC is available, it should be checked by a manual system. A thorough double check system from the observer to the lanyard is the key to artillery safety.

I FFORCEV Artillery

PACIFICATION POINTERS



(U) Consolidate Village Defense The defense of relocated hamlet consolidations should be accomplished in stages, when enemy interference is expected. Military units should provide area security during the relocation of families, houses and rice huts. A defensive compound should be constructed during the relocation phase for the resident civic action (CA) team so that a smaller military unit can be used in conjunction with the CA team as the relocation operation terminates. As the relocation phase ends the CA team should work through hamlet officials to recruit People's Self Defense Force (PSDF) or Popular Force Volunteers. The team can also assist hamlet officials in requesting weapons and training from the GVN. Concurrently the self-help construction of family bunkers and village perimeter fortifications should be started. Initially the PSDF can be trained, equipped with hand grenades, claymore mines, trip flares, and other warning devices, and deployed in LPs. In the event of attack, protection can be provided to the PSDF by the use of planned withdrawal routes and bunkers covered by grazing fire from the CA team compound. At this stage military reaction forces can be used as reinforcement during an attack. When the perimeter fortifications and armed PSDF or PF training are completed, reaction

forces for attempted perimeter penetrations can be organized from village defense assets. Defense plans should be maintained continuously during consolidation which include provisions for civilian safety, supporting fires, observation of the perimeter, withdrawal of forces to strong points in the event of perimeter penetrations, and counter-attack or reaction force support.

4th Inf Div

(U) Integration of PSYOP with MEDCAP Operations. During recent MEDCAP Operations, 4th Division Civic Action Teams have increased the scope of the MEDCAP to include PSYOP material dissemination. This included the dissemination of leaflets, posters and newspapers dealing with personal hygiene, 3d Party Program, VIP Program, Chieu Hoi, and US/FWMAF image. The dissemination of PSYOP material during a MEDCAP Operation was greeted with more interest and enthusiasm than if disseminated alone. In addition, the personal nature of a MEDCAP gave the most effective "face-to-face" PSYOP type operation. The people feel that since they have been helped physically, the printed matter disseminated may also be of some help. Through the MEDCAP, a bridge was built to the people and they were more receptive to PSYOP materials. During this period of combined operations, there was an increase in intelligence information given to the CA teams.

4th Inf Div

(U) Regularly Scheduled MEDCAP Missions. The surgeons of the 173d Airborne Brigade have been very active in local MEDCAP missions. In villages and hamlets regularly visited on a weekly or ten day schedule, they have observed that many minor illnesses or diseases common to the Vietnamese people have almost disappeared. Thus, for maximum benefit, MEDCAP missions should be held regularly in key hamlets or villages rather than at random sites at random times, which allows no medical "follow-up".

(U) Quick Rebuild. A tremendous psychological impact is made when homes destroyed by Viet Cong terrorists are immediately rebuilt. A policy of "Quick Rebuild" has been established in IFFV, DEPCORDS, using FWMAF and ARVN resources. It is designed to render timely and humanitarian assistance by bringing rapidly to bear materials and relief funds to those localities where homes have been destroyed, families torn apart, and bread winners killed or incapacitated. The people so affected are made quickly to see that their government cares about them and does something to relieve them in their adversity. These people as a general rule never like to leave their land and crops and when "Quick Rebuild" is accomplished, the loss and trauma for them is lessened.

DEPCORDS I FFORCEV

(U) Reduction of RD Cadre Desertions. Remarkable results have been attained in Ninh Thuan Province in reducing the number of desertions of RD cadre. By applying the following, Ninh Thuan reduced its desertion rate from 6.9% in September 1968 - the highest in II Corps - to 1.0% at the present time.

a. Development of RD awareness among Province and District Chiefs.

b. Institution of local measures, such as:

(1) Unannounced inspections of RD cadre.

(2) Deduction of pay and/or confinement as punishment for AWOLS.

(3) Establishment of mobile checkpoints at strategic locations to check cadre leaving their teams.

(4) Making cadre available for the draft after the second AWOL.

(5) Building team morale, i.e., providing for personnel service and visiting teams at least once per month.

DEPCORDS II FORCNAV



AIRCRAFT SECURITY

(U) Enemy Mining of Airfields. There have been recent incidents where mines have been emplaced on both the runways and perimeter roads of unsecured airfields. The enemy continues to have the capability to mine runways and position claymore mines and other explosive charges in areas immediately adjacent to runways, parking ramps and perimeter roads. Commanders who have unprotected airfields under their jurisdiction should provide security for these airfields by all practicable means available. It is recommended that night sight-finding devices and ambush and reconnaissance patrols be used to forestall sapper activity at unprotected airfields. In addition, responsible commanders should include as SOP that a sweep of the airfield is conducted each day before the arrival of the first scheduled aircraft. It should be noted that many isolated areas are virtually completely dependent upon aerial resupply means and the destruction of aircraft and runways could close the airfield and seriously impede resupply operations.

I FFORCEV Aviation

MAINTAINING MORALE



(U) The "Pill". The principal objection of the troops to ingesting the chloroquine-primaquine anti-malarial tablet has been the complaint of severe stomach cramps and/or diarrhea. It has been found that if the tablet is broken into four pieces and consumed after meals, the incidence of these side effects is markedly reduced.

173d Abn Bde

(U) Recovery of MIA Personnel. Military obligations to MIA personnel and their relatives never cease. Every unit and activity must remain constantly alert to the responsibility of recovering these individuals and of monitoring intelligence reports which may lead to their recovery. Not only are concentrated searches necessary initially when a person is listed as MIA, but commanders should take repeated actions, to locate these individuals especially during slack periods and when their units conduct operations within areas where MIA personnel were last seen.

AG I FFORCEV

(U) Expediting Awards. The importance of accurate and timely submissions of recommendations for awards of valor cannot be overemphasized. Prompt recognition of acts of valor contributes significantly to individual morale and unit esprit. Inasmuch as these awards are intended to recognize those individuals who have distinguished themselves by heroism at the risk of their lives, it is thus incumbent upon all concerned to insure that these recommendations are initiated promptly, prepared accurately, reviewed carefully and processed expeditiously.

AG I FFORCEV

TALKING TO OTHERS



(U) Working Together. US/FWMAF/ARVN coordination has been highly successful in recent pacification operations within II CTZ. Do you have good coordination? Ask yourself these questions:

1. Coordination of Intelligence Activities:

- a. Has intelligence information been exchanged between US units and Province/District Officials prior to, during and after operations?
- b. Has a blacklist of the operational area been obtained?
- c. Have US units and DIOCC/PIOCC's coordinated the following items on reporting VCI:
 - (1) How to contact DIOCC/PIOCC?
 - (2) What information can the DIOCC/PIOCC provide the tactical unit?
 - (3) What information is needed by the DIOCC/PIOCC?
 - (4) If contact with the enemy results in enemy KIA, CIA or detainees, what else should be done (i.e. unit commander immediately notifies the DIOCC/PIOCC and provides their representatives with an opportunity to determine if any of the enemy casualties are VCI)?

2. Coordination of Military/Pacification Programs.

a. Do US Tactical commanders meet periodically with Province/District Officials to coordinate operations; say, at least on a monthly basis, or more often? Are the following items included for discussion at these meetings:

(1) Identification of potential target areas for military operations?

(2) Exchange of intelligence and information required for the conduct of military operations, in attack on the VCI, Chieu Hoi, PSYWAR, Refugee and Pacification Program?

(3) Coordination and provision of systems for controlling air, artillery, naval gunfire and heavy support for territorial forces?

(4) Programming and coordination of civil affairs/civic action projects?

b. Are US military commanders providing assistance in the following areas consistent with operational missions:

(1) Attack on the VCI by providing cordon forces?

(2) Upgrading hamlet security by interdicting enemy infiltration and conducting operations in proximity to hamlets targeted for pacification?

(3) Providing security during rice and salt harvesting activities?

(4) Coordinating and integrating pacification projects into overall plans for an operational area?

(5) Providing assistance in relocation of refugees to include use of transportation and other logistical support?

c. Are US operations involving use of herbicides coordinated with the Province Chief to include:

(1) Selection of targets?

(2) Province Chief's written indemnification in the event of any accident involving friendly crop damage?

d. Are PSYOP activities coordinated with the Provincial PSYOP Coordinating Center?

If the answers are "yes", you should have good coordination.

If the answer to any one is "no", better check your coordination again.

G3 I FFORCEV

CONFIDENTIAL



COVER YOUR HEAD

(C) Overhead Cover for RF/PF Installations. Many of the enemy initiated contacts against the RF/PF installations are standoff attacks employing indirect and direct fire weapons, with friendly casualties resulting. One of the primary reasons for the high casualty rate is a lack of adequate overhead cover. Properly constructed overhead cover not only affords protection against enemy standoff attacks but can be highly useful in defeating an enemy that has breached the perimeter: i.e. the friendlies take cover and VT fused artillery is called in on the friendly position. Because overhead cover is not always adequate, we continue to sustain too many casualties. Advisors should press upon their counterparts this important measure of defense. It can make the difference between success and defeat; between life and death.

DEPCORDS I FFORCEV

CONFIDENTIAL 121 19

A SUCCESSFUL AMBUSH



(U) You Versus Charlie. All too often a friendly ambush patrol gets itself ambushed. The main consideration for a successful ambush is surprise. This is achieved not by digging in, as the ambush is not a defensive position, nor by using the same sites over and over, but by moving with stealth into well chosen, concealed positions preferably during the hours of darkness. Actual movement into position is critical, because a single footprint on the trail may warn the enemy, and give away the ambush, or even worse set up the conditions for a counterambush. The ambush patrol should travel to its selected site using all available cover and concealment. Before the main body moves into the ambush position, a small element should first check it out. When the area has been thoroughly checked and found to be clear then the main body can move in. Flank and rear security should always be established. The patrol must remain silent and alert while waiting to initiate the ambush. Remember, the two watchwords of the ambush -- surprise and simplicity. If you do you will improve your chances of "getting a jump on the enemy permanently", and of foiling his counterambush attempts.

G3 I FFORCEV

122

20

CONFIDENTIAL
ACCURATE COUNTING

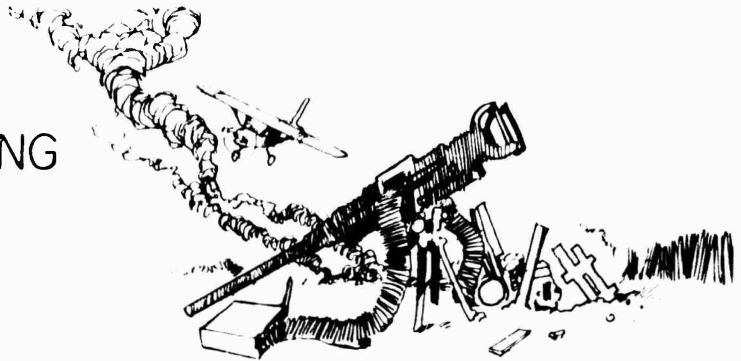

(C) Ground Confirmation of FAC Reported KBA. In each case where post strike analysis of a tactical airstrike indicates possible enemy killed by air, the observers/FACs should notify ground control for immediate relay to the responsible ground commander. The ground commander should determine if a ground force follow-up or low level air strike cavalry reconnaissance should be conducted to exploit the strike and inform the FAC through ground control. The FAC should fly Combat Air Patrol (CAP) over the target until arrival of the exploitation force unless he is forced to leave the area for operational reason or because of low fuel. If the FAC must leave another FAC should assume the CAP. FACs should use available fire support means to isolate the target area prior to the arrival of the ground follow-up unit, and direct contact should be established with the ground commander. The FAC should remain overhead to provide direction and support to the ground unit. Ground commanders should react rapidly to reduce CAP time as well as to insure maximum exploitation. G3 I FFORCEV

CONFIDENTIAL

123 21

CONFIDENTIAL

BETTER USE OF PERIMETER FORCES



(C) Putting LZ Perimeter Defense Assets to Work. Normally, there is a diminished requirement for LZ perimeter defense forces during daylight hours. Since this makes available a sizeable fighting force on a regular and predictable basis, the 173d Abn Bde has developed two types of operations which make use of these ready and available combat assets.

a. SKYTRAP Operations: This combined RVNAF/US operation is a one day cordon and search operation. The concept involves the early morning airlift of cordon forces (US LZ Perimeter defense forces) into multiple landing zones from which a rapid cordon is established around the target hamlet. The search force (ARVN/PF/PF), accompanied by an IPW team and district population resource control teams, is picked up from a pre-designated point and airlifted to the area from which it passes through the cordon force and initiates search operations against VCI blacklist hamlets.

b. SKYSWEEP Operations: This operation is a variation of the "eagle flight" using an infantry platoon from the LZ perimeter defense force, four slick aircraft, two gunships and a reconnaissance aircraft. All elements except the reconnaissance aircraft remain on a five minute alert status

CONFIDENTIAL 124 22

CONFIDENTIAL

at the LZ. The aircraft flies visual reconnaissance in assigned areas of likely enemy activity. When a sighting is made, the SKYWEEP force is notified, and the operation is initiated.

173d Abn Bde

CONFIDENTIAL

125 23

CONFIDENTIAL

HOW TO HEAR & SEE CHARLIE
*ONE WAY—STAY AWAKE!
ANOTHER—EMPLOY EARLY WARNING
METHODS*



(C) Early Warning for RF/PF Operating Bases. The majority of successful night actions by the enemy against RF/PF can be directly attributed to the fact that either somebody on lookout went to sleep or that early warning devices were not used properly (i.e., such as trip flares, grenade traps, listening posts and ambushes). Here are several recent cases in point:

Case One - A squad size VC force penetrated four rows of barbed wire barriers and entered an RF operating base undetected. The use of listening posts, trip flares, and ambushes could have minimized the element of surprise.

Case Two - A VC force, under the cover of darkness avoided twelve separate ambush locations and assaulted a defended village. Proper use of trip flares and grenade traps between ambush positions could have helped to prevent the enemy from infiltrating into the village.

Case Three - An RF company operating base was overrun by a VC force who had dug foxholes within 25 meters of the compound's barbed wire fences. Question: "How could this happen?"

CONFIDENTIAL 126 24

CONFIDENTIAL

Case Four - Under the cover of a mortar attack, 4-6 VC crawled under a single strand of barbed wire fence and entered an RF operating base. They proceeded to fire B-40s and automatic weapons at the bunkers and at personnel within, causing many casualties. Question: "Where were the listening posts and ambushes and what were they doing? Sleeping?"

Case Five - A district compound was attacked and overrun by an estimated two VC companies utilizing 75 mm, 82mm mortars, 60mm mortars and RPG rockets. The perimeter was breached and the large enemy force was allowed to move without interference to inflict heavy casualties on the defenders. Question: "Or were they defended?"

Case Six - A hamlet defended by one RF platoon and a Popular Self Defense Force came under a coordinated two phase attack by an estimated two VC companies. During the ensuing battle a sapper squad was able to penetrate the hamlet's defense and inflict casualties upon the defending forces and the civilian populace. Because of a heavy rain storm, the commander elected not to establish listening posts nor to position ambush forces. Observation: It is essential that RF and PF units manning operating bases and outposts have alert, awake sentries during nighttime hours and that they take full advantage of available assets to turn the tables on the would be attacker.

Moral of the Story: To defenders of outposts: "STAY ALERT, OR EXPECT TO BE ZAPPED BY CHARLIE"

CONFIDENTIAL 127 25

CONFIDENTIAL

FINDING THE ENEMY



(C) SCORPION Operations. A new 4th Division concept called SCORPION has produced especially good results. SCORPION (Hunter-Killer Team) is a rapid reaction force for special combined operations for reconnaissance, personnel detection, identification and overt neutralization of intelligence targets. The Hunter-Killer Team (SCORPION) is composed of two Hunters (OH-6A, LOH), two Killers (AH-1G, Cobras) and one XM-3 Airborne Personnel Detector. The team employs the Airborne Personnel Detector, RCA (Riot Control Agent-CS), flechette and HE rockets, along with the normal ordnance of Cobra gunships. SCORPION is employed against intelligence targets of a fleeting nature. Artillery, if in range, is visually adjusted into the strike area as a follow-up. Air strikes are employed if the target warrants. SCORPION is also useful in reconnoitering areas, checking clearance of landing zones and confirming or denying intelligence reports.

4th Inf Div

CONFIDENTIAL

128 26

CONFIDENTIAL

OPERATIONS: HELPFUL TACTICAL HINTS



(C) Enemy Road Ambush Tactics. On two occasions recently, road clearing and mine sweep teams encountered trash and/or debris on the road surface. They had inadequate security procedures in effect. When the friendly element stopped to check and clear the debris, the enemy force initiated contact. Security elements should proceed with extreme caution when encountering debris. By maneuvering to the flanks and by using reconnaissance by fire, friendly troops can trigger the enemy ambush early and quickly gain fire superiority over enemy forces. 173d Abn Bde

(C) Marking of Landing Zones During Combat Assault. In a recent airmobile combat assault, troops disembarking from the initial aircraft found the landing zone to be "cold" and marked it with the appropriate green smoke. At the same time, a door gunner on an incoming "slick" decided to mark the landing zone for subsequent aircraft and did so with red smoke. With both colors displayed, confusion resulted. Luckily, the ground commander was able to correct the situation before subsequent aircraft aborted. Aviation personnel should be thoroughly briefed before any combat assault that it is the re-

CONFIDENTIAL 129 27

CONFIDENTIAL

sponsibility of the ground commander to determine whether a landing zone is hot or cold and to mark it with appropriate colored smoke: Green for "Cold"; red for "Hot".

173d Abn Bde

(U) Tunnel/Cave Operations. Here's one way to search out enemy tunnels and caves. Use chicken wire and hand grenades. Throw a fragmentation grenade into the tunnel or cave and then place a small piece of "chicken wire" over the entrance. In this way one avoids a boomeranging "return" of the grenade by tunnel occupants. This simple technique reduces injury to tunnel teams and does not weight down the people involved.

173d Abn Bde

(U) Use of Aerial Loudspeakers in Cordon and Search Operations. In conducting cordon and search operations in the past, we have noted that villagers are often alarmed by the sudden appearance of our troops and try to hide or escape, thereby complicating the operation. Thus we are using aerial loud speakers to advise the occupants of a village of our coming and the purpose of our being there. This has helped to reassure innocent civilians that no harm would befall them. Usually they follow our instructions to the letter, thereby expediting the operation. Needless to say, the use of the aerial loudspeakers must be correctly timed to preclude premature warning of the operations.

4th Inf Div

CONFIDENTIAL

130 28

CONFIDENTIAL

(C) Cordon-Search Innovation or "Charlie Gets Hungry and Thirsty, Too." A technique recently developed in Binh Dinh Province during cordon and search operations met with considerable success. The technique requires that all of the hamlet's rice and other food be collected (carefully identified and protected) and that all water resources be controlled during the operation. The cordoning unit prepares and cooks the rice for the people during the operation. The guerrillas hiding out in the area soon get very hungry and are more inclined to come out of hiding. Your unit might try this out.

DEPCORDS I FFORCLV

CONFIDENTIAL

HOW TO OBTAIN INFORMATION ON THE ENEMY



(C) Volunteer Information Program (VIP). In order for the VIP to be successful the Vietnamese people must be informed of the program. The 173d Airborne Brigade has concentrated its effort making the people aware of this program and has attained valuable information as a result. The brigade has mounted an intensive advertising campaign using posters, leaflet drops in selected areas and vehicle loudspeaker teams. Another important way is "word of mouth". All soldiers should be made aware of the Volunteer Informant Program so that they can spread the word to the Vietnamese. Our February results have been extremely productive.

173d Abn Bde

CONFIDENTIAL

132 30

BE ALERT TO VC TERRORISTS
THEY STRIKE AT WEAKNESSES

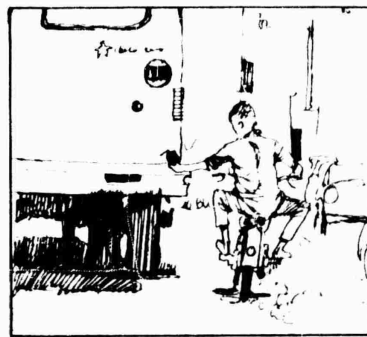

(U) Terrorist Tactics in Urban Areas. A recent incident in NHA TRANG left two US servicemen killed and twelve wounded when a terrorist pitched two hand grenades into a crowded bus stop. The terrorist escaped on a motorcycle. The Viet Cong have been known to use explosives, poison, and even ground glass placed in apparently sealed soft drink and beer bottles in their attempts to incapacitate unwary US forces personnel. Recently a soldier lost his right hand when a cigarette lighter he purchased in a local marketplace exploded. The enemy had replaced the cotton fuel absorbing pads with C-4 explosive. All US personnel should know about terrorist tactics. Here are some pointers:

Don't congregate in groups -- they make lucrative targets.

Be constantly alert and observant, particularly of motorcyclists when they are riding by.

Insofar as possible, vary your activities; avoid fixed patterns.

Use the buddy system when away from the security of your installation.

Be careful when purchasing goods on the local economy.

Avoid eating foods or drinking beverages in strange establishments, especially, from street vendors.

Do not leave the relative security of protected installations unless it is necessary.

Tell newly arrived personnel about terrorist tactics and how to avoid becoming their victims.

Remember terrorists observe and strike at your weakness, not at your strength.

G3 I FFORCEV

APPENDIX I

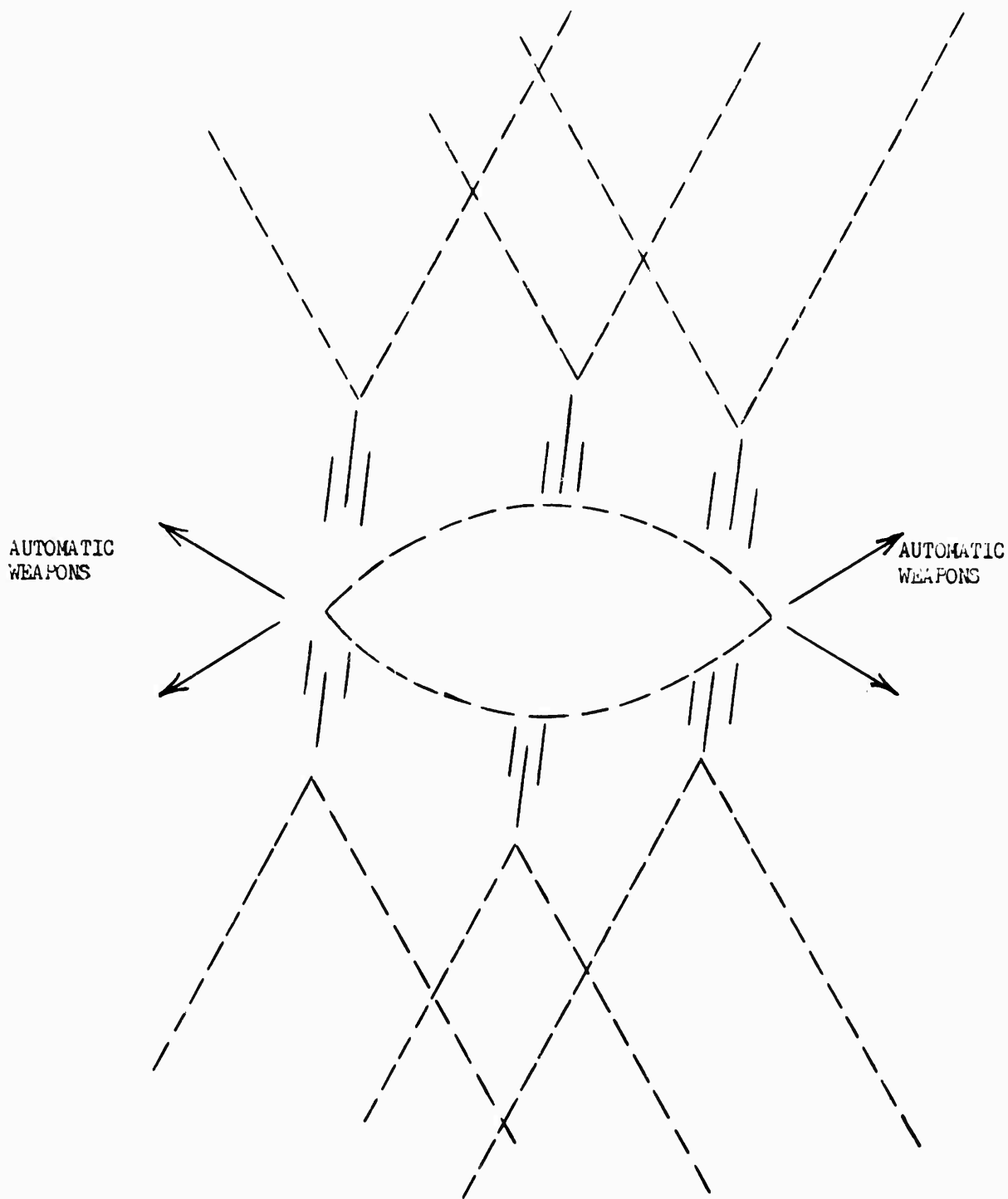

HO. ITZERS DEPLOYED FOR BEEHIVE EMPLOYMENT

CONFIDENTIAL
**TACTICAL
NOTES**

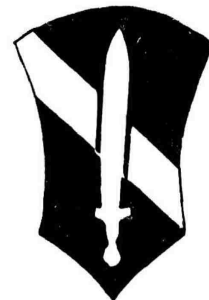

I FIELD FORCE VIETNAM

IN THIS ISSUE

- * HAMLET DEFENSIVE SYSTEM.
- * ENEMY ROCKET TACTICS.
- * TREE TOP SNIPERS.
- * WAR DOGS.
- * BATTLEFIELD POLICE PAYS OFF.

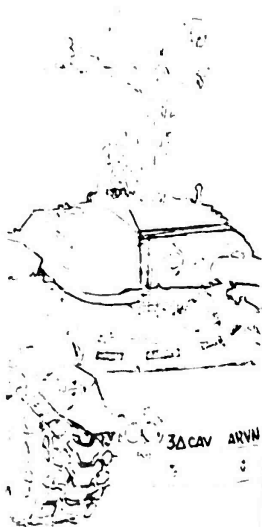

Incl 6

MARCH 1969

136
DOWNGRADED AT 3 YEAR INTER-
VALS DECLASSIFIED AFTER 12
YEARS, DOD DIR 5200.10

CONFIDENTIAL

CONFIDENTIAL

TACTICAL NOTES

VOL 2 NO 3

I FFORCE V

PURPOSE

In producing TACTICAL NOTES, I FFORCEV Headquarters compiles and highlights in each edition up to date, helpful hints from the counter insurgency battlefields in II Corps Tactical Zone. Study them. Put them to use. Pass them along to others.

Contributions from commanders of all assigned and OPCON units, as well as other organizations receiving the NOTES, including advisors with ARVN units and liaison officers with ROK units, are highly desired and solicited. Pertinent details of "tactical lessons learned" should be recorded as they happen. All contributions submitted should reach this headquarters by the fifteenth of each month.

FOR THE COMMANDER:

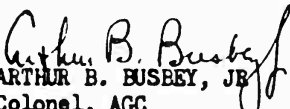
ARTHUR B. BUSEBEY, JR.
Colonel, AGC
Adjutant General

DISTRIBUTION:

H

REGRADED UNCLASSIFIED
WHEN SEPARATED FROM
CLASSIFIED INCLOSURE

137

CONFIDENTIAL

C O N T E N T S

ARTILLERY TECHNIQUES

Use of CS with Artillery	6
Heights of Burst for Improved Conventional Munitions	7
Artillery Preparations of Landing Zones	8
Field FSCC	8

PACIFICATION POINTERS

Civic Actions	9
-------------------------	---

KEEP THE ENEMY OUT

Hamlet Defensive System	10-11
-----------------------------------	-------

UTILIZING PROPAGANDA

Poetry for PSYOPS	12
-----------------------------	----

ENEMY ROCKET TACTICS

NVA Tactics After Rocket Attacks	13
--	----

OPERATIONS: HELPFUL TACTICAL HINTS

Relay Station	14
Wire Cutting	15
Convoy Loading Security	15
Conduct of Platoon HAWK Night Operations	16
Use of the Smoke Pole	17
Enemy Use of Camouflaged Punji Stakes	17
Enemy Use of Dummy Positions	18
Enemy Locations in Stream Beds	18
Ground Follow-Up of Secondary Explosions	19

LOOK UP

Tree Top Snipers	20
----------------------------	----

DON'T EXPOSE YOURSELF

Communication Trenches	21
----------------------------------	----

BE OBSERVANT

Location of Caches	22
------------------------------	----

SURE PROTECTION

Obtaining Overhead Cover in Night Defensive 23
Positions

CHEMICAL TECHNIQUES

New Technique for Use of the E-8 CS Tactical 24
Launcher for Aerial CS Drops

Small Area CS Contamination 25

SHOOTING FROM ALL SIDES

Rear Firing Ports in Bunkers 26

TRACK DOWN THE ENEMY

War Dogs 27-28

BATTLEFIELD POLICE PAYS OFF

Enemy Use of Recovered Material for Mines 29-30

HELICOPTER SAFETY

Location of Unit Helipads 31

CONFIDENTIAL

ARTILLERY TECHNIQUES

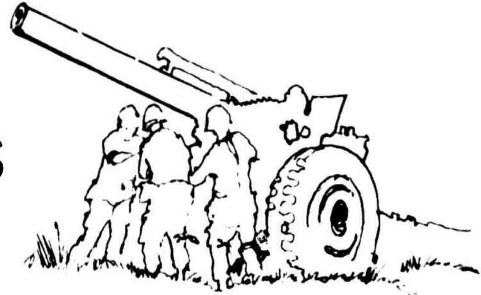

(C) Use of CS with Artillery. The 3d Armored Cavalry Squadron, while conducting daylight security of Highway 14 from Pleiku to Kontum, has found that the enemy has occupied firing positions during the day along the Squadron withdrawal route to harass its return to Pleiku. To counter this enemy tactic, the Squadron Commander has used the E-8 tactical CS launcher, ground emplaced, to put CS on the enemy firing positions, thus forcing the enemy to abandon his protective cover. The CS attack has been promptly followed by artillery and mortar fires. This technique has been highly successful in reducing harassing enemy fire. DSA, II Corps (3d ACAV Squadron)

CONFIDENTIAL

6

141

CONFIDENTIAL

(U) Heights of Burst for Improved Conventional Munitions.

The firing data for conventional munitions (FIRECRACKER) computed by FADAC* can differ substantially from that derived from manual computations employing the addendum (with changes) to the tabular firing tables. This difference results from the new optimum heights of burst (HOB) utilized by the FADAC which aid in decreasing the effects of low level winds and in reducing enemy reaction time. Review and Analysis Information Note - 2, dated 3 February 1969 and published by the Fort Sill Gunnery Department, lists both manual and FADAC HOB's. The following table is an extract from this publication:

CHARGE AND HOB (IN METERS)-FADAC							
CALIBER	1	2	3	4	5	6	7
105mm	230	240	250	270	295	330	265
155mm (GB)	230	245	265	290	340		
(WB)			285	310	345	380	425
8 inch	230	240	255	275	295	320	330

The above HOB's will be incorporated in new firing table addenda soon to be published. Copies of the Fort Sill information note have been distributed to II CTZ units by HQ, I FFORCEV Artillery. Additional copies are available upon request.

I FFORCEV Arty

* For both issue 2 FADAC tape programs.

CONFIDENTIAL

142 7

(U) Artillery Preparations of Landing Zones. During the dry season, the use of point-detonating HE and white phosphorous artillery rounds for landing zone preparations increases the hazards of smoke and fire to heliborne assaults. These can be significantly diminished, while still neutralizing the enemy, by employing the PD-fused round in the near vicinity of the landing zone and the VT-fused round on the landing zone. 173d Abn Bde

(U) Field FSCC. In a recent combat sweep where ARVN, Rangers, and US Infantry were maneuvering in close proximity to one another, the clearance of artillery fires was an acute problem. Friendly units were being mortared from positions that were in the AO of other friendly troops. Countermortar fires were delayed due to the difficulty in obtaining clearance to fire into another AO. The solution to this problem was to establish a field FSCC with a representative from each friendly force operating in the area who could ensure rapid clearance of fires in all situations.

DSA, II Corps (24th STZ)

CONFIDENTIAL

PACIFICATION POINTERS



(C) Civic Actions. A division wide Monthly Civic Action Conference has given new impetus to this program in the 4th Infantry Division. Because divisional civic action teams are dispersed over a wide area, lateral sharing of valuable on-the-job experience has been difficult. Further, civic action personnel have not fully understood their part in the total multi-agency joint American/GVN Civic Action Program. The monthly conference provides an opportunity for civic action personnel to exchange information and lessons learned from their own village/hamlet experiences. In addition, the monthly conference features presentations by personnel from outside the division, e.g., CORDS, JUSPAO, District and Provincial GVN and US Advisory personnel. The tone of the monthly conference is intentionally informal to encourage the timely consideration of problems facing the divisional civic affairs teams.

4th Inf Div

CONFIDENTIAL

144 9

CONFIDENTIAL
KEEP THE ENEMY OUT

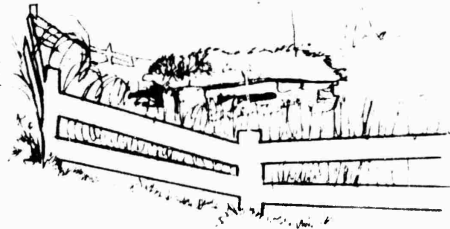

(C) Hamlet Defensive System. In many areas the Montagnard custom is to fortify hamlets with a protective fence. Recent inspections of these fences in several Montagnard hamlet defensive systems have revealed that defense bunkers built inside of them offer virtually no fields of fire from the bunker to areas outside the fence. Thus, the custom of building fences coupled with the improperly placed bunkers, seriously detracts from the worthiness of the hamlets's defense system. This situation should be corrected. A problem exists, however, in how to achieve good fields of fire and a tighter defense without offending the Montagnards and their custom of building wood fence fortifications. A technique which has proven very satisfactory in overcoming this problem, and still meets with the approval of the hamlet officials, has been developed. The wooden fence is placed around the entire hamlet. Fences are often constructed in depth, i.e., two or three rows deep with punji stakes between the fence rows. A moat is dug around the hamlet with punji stakes placed in the moat. By building a series of three-man bunkers into, and as a part of the forward fence, the

CONFIDENTIAL

security of the hamlet is considerably enhanced. This technique affords the personnel occupying the bunkers good fields of fire on areas outside the fence. An example of one system, used in a hamlet surrounded by a 1500m fence, was to emplace 53 three-man bunkers approximately 30m apart, built into the forward fence and interlocked by a trench system to achieve interior lines of communications within the hamlet. Barbed wire, concertina and foot entanglements were placed in front of the forward fence. Additional fences and punji stake defenses were built behind the forward fence. Each of these fence lines feature built in bunkers and connecting trenches, which serve as supplementary defensive positions. A diagram of this defensive system is shown at Appendix 1.

ADV Tm 25 MAT II-17

CONFIDENTIAL 146 11

UTILIZING PROPAGANDA



(U) Poetry for PSYOPS. Letters, poems and diaries captured off NVA/VC personnel are of tremendous value in developing leaflets directed at the same people. Propaganda leaflets have often been criticized by Hoi Chanh and POWs because they are "too American" and lack the true feelings of the Vietnamese language. Using a poem, part of a letter or diary written by a NVA/VC, adds credibility to the leaflet and increases the possibility that the recipient will believe the entire content of the leaflet. Close coordination between intelligence and PSYOPS personnel is necessary to insure that material of this type is fully exploited for its psychological value. 4th Inf Div

CONFIDENTIAL

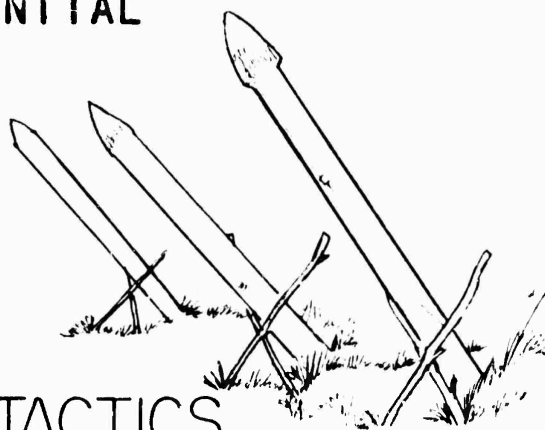

ENEMY ROCKET TACTICS

(C) NVA Tactics After Rocket Attacks. On 18 January 1969 and 26 February 1969, during rocket attacks against Ban Me Thuot, the enemy appeared to be using diversionary tactics to draw gunships away from rocket positions. In both attacks, when gunships were launched to search for firing positions they received small arms ground fire from locations some distance from the actual rocket firing positions. Pilots of gunships and VR aircraft should be briefed on this tactic and instructed to concentrate on locating the firing positions before expending ordnance. DSA, II Corps (23d DTA)

CONFIDENTIAL 148 13

CONFIDENTIAL

OPERATIONS: HELPFUL TACTICAL HINTS



(U) Relay Station. When planning operations in rugged terrain where communication problems should be expected, commanders and staffs must anticipate these difficulties and explore alternative solutions. During a recent operation in very broken terrain, it became apparent that communications with maneuver elements moving through the valleys would be marginal at best. The best solution to this problem was to establish an isolated relay station; however, this would require a prohibitive number of troops for security. Close coordination with other units operating in the vicinity led to the discovery of an established relay station/observation post. Thus, a minimum of personnel were required to collocate a relay with the established station and continuous communications were maintained.

DSA, II Corps (24th STZ)

CONFIDENTIAL

149 14

CONFIDENTIAL

(C) Wire Cutting. On several recent occasions, sappers have attacked and have quickly penetrated very strong defensive positions while the attention of the defending forces has been diverted by a mortar attack. Subsequent investigations have revealed that the sappers cut the defensive wire prior to the attack. When the attack started, the sappers went directly to the lanes cut through the wire and penetrated the defensive position without use of either Bangalore torpedoes or satchel charges. It is imperative that a thorough inspection of perimeter wire be made regularly to detect gaps in the perimeter wire.

DSA, II Corps (G3 Advisor)

(C) Convoy Loading Security. A favorite NVA tactic when they have spotted a waiting convoy has been to site mortars and recoilless rifles on the rendezvous positions and wait for the tired troops to board their trucks. The NVA then bring maximum fire on the convoy. A secure tactic for moving infantry with their transportation is to keep the truck column in a secure area until the infantry is near the highway and ready to load. The trucks then move to the pick-up site where the infantry mounts without delay. If armored cavalry units are available, they can deploy to secure the entrucking operation. In such manner, the enemy does not have time to emplace his indirect fire weapons and a possible enemy ambush is avoided.

DSA, II Corps (3d ACAV Sqdn)

CONFIDENTIAL

150 15

(U) Conduct of Platoon HAWK Night Operations. The 2-503d Infantry (Airborne), 173d Airborne Brigade recently instituted a program of effective night operations utilizing one platoon at a time from each of the rifle companies of the battalion. Each of the platoons designated for night operations is cycled through night operations consisting of the following three phases - one phase each night.

a. Phase I: Entire platoon is utilized for conduct of night operations.

b. Phase II: 50% of platoon is utilized for night operations and 50% get maximum rest in a platoon laager site.

c. Phase III: Entire platoon rests in a laager site with the company CP and acts as company reaction force.

During daylight hours those personnel utilized for night operations get maximum rest. Personnel who get normal rest at night conduct daylight patrols and reconnoiter night ambush sites prior to noon. Occupation of laager sites during the afternoon takes advantage of a relatively secure area to prepare the night operations. This is usually the period of least VC activity. Night operations are conducted by squad and smaller elements in static ambushes and roving ambush patrols.

173d Abn Bde

(U) Use of the Smoke Pole. During several recent operations in the highlands, normal identification of unit locations by smoke grenades has often been prevented by ground fog and close overhanging jungle foliage. A simple means to mark positions by smoke under such circumstances is to tie two bamboo poles together and attach the smoke grenade to one end. Once identification is requested, the grenade is "popped" and the pole is raised, thus permitting the smoke to penetrate through the ground fog and ground foliage.

DSA, II Corps (2d Ranger Gp)

(U) Enemy Use of Camouflaged Punji Stakes. During the dry season grass fields and harvested rice fields are easily set afire by artillery, air strikes, etc. The enemy uses a special type punji stake in burned out areas. This stake is a non-flexible black metal rod with a barbed tip. The black rod punji stake is stuck into the ground at an angle in the midst of the charred grasses. It is extremely difficult to detect because of its color. Caution should be exercised in crossing such areas. An awareness of the above technique may reduce casualties.

TF South

(U) Enemy Use of Dummy Positions. The VC often build poorly camouflaged dummy bunker positions in order to draw unwary allied units into prepared killing zones. These dummy positions are usually complete with fresh trail activity leading to the bunkers. Well camouflaged enemy positions are located nearby with good observation and fields of fire covering the dummy positions. When a careless allied unit approaches the dummy positions, it is taken under fire by enemy forces in the well-concealed bunkers. Awareness of this enemy tactic and caution in approaching obvious enemy positions may reveal the true location the the enemy force and negate this tactic.

TF South

(U) Enemy Locations in Stream Beds. When conducting operations be especially cautious when approaching stream and river beds. The VC and NVA often choose a water source as a location for their base camps. Bunkers and fighting positions may be found along the stream or even inside the bank, staggered from side to side to insure good fields of fire. When walking parallel to the stream, fighting positions inside the bank may be difficult to observe. The enemy has used this technique in Binh Thuan Province during the dry season.

TF South

(U) Ground Follow-Up of Secondary Explosions. During recent operations it has been the experience of this command that immediate and aggressive follow-up of secondary explosions, caused by placing the artillery fire into suspected enemy locations, produces rewarding results. An example of such an operation is the 3-503 Abn Inf's follow-up of three secondary explosions caused by the artillery fire in western Lam Dong Province. In the general vicinity of the explosions the unit discovered several important munitions caches, training areas and trails in addition to making contacts with small enemy forces. TF South

CONFIDENTIAL

LOOK UP

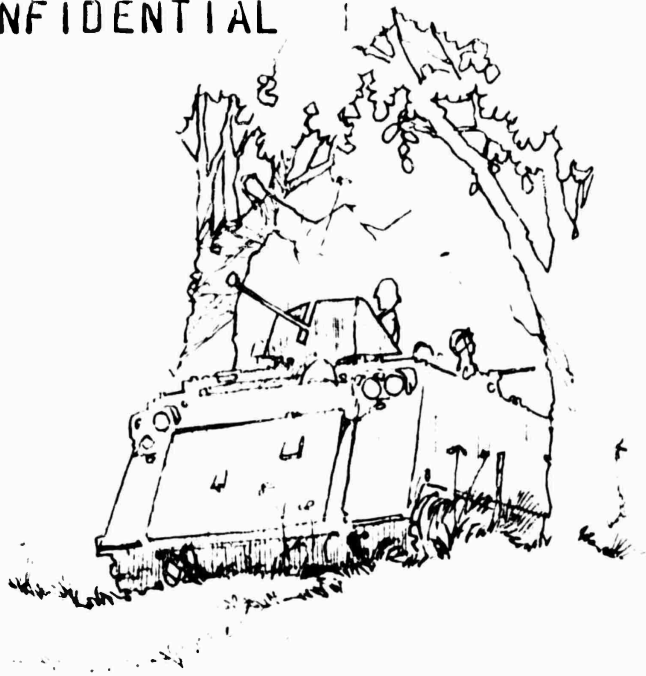

(C) Treetop Snipers. During a recent action in which friendly troops were counter-attacking an NVA unit which had overrun a village, elements of a mechanized unit received B40/41 rocket fire from enemy positions in treetops. The treetop firing positions gave the enemy gunners the advantage of surprise since the reconnaissance by fire and visual observation of the M113 crews is usually directed at ground level as the armored vehicle moves forward. Reconnaissance by fire into suspicious treetops may be necessary to counter this new tactic.

DSA, II Corps (G3 Opn)

CONFIDENTIAL 155 20

CONFIDENTIAL

DON'T EXPOSE YOURSELF

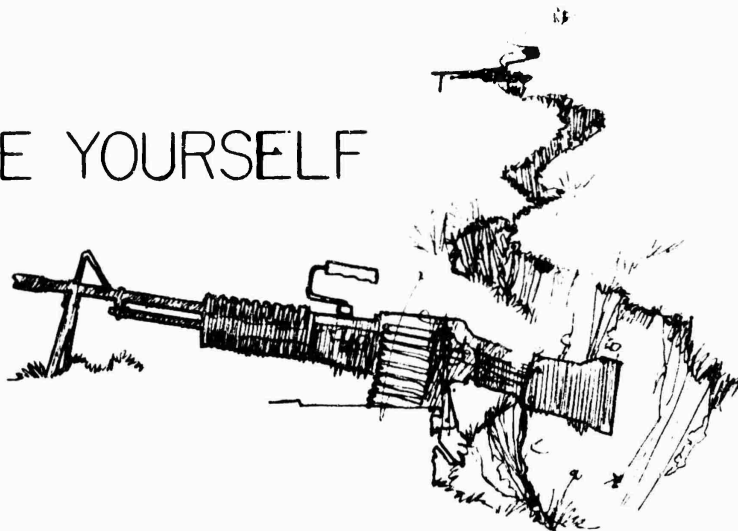

(C) Communication Trenches. In several recent incidents, stand-off attacks on friendly bases and outposts have been accompanied by ground and sapper attacks. The perimeter defense positions were excellent, however they normally were not manned with sufficient strength to stop the attack. With the absence of communications trenches the reaction forces had to subject themselves to undue exposure to indirect weapons fire as they moved to the perimeter. It is imperative that bases and outposts have a system of communication trenches by which troops can move within the perimeter without exposing themselves unnecessarily to direct and indirect weapons fire.

DSA, II Corps (22d DTA)

CONFIDENTIAL

156 21

CONFIDENTIAL

BE OBSERVANT



(C) Location of Caches. Units operating in suspected enemy base areas should look for enemy caches along or near lines of communications; a favorite location is along or near river and canal banks. With the advent of the rainy season, the detection of enemy weapons and ammunition caches becomes easier. After a heavy rain, a depression in the ground will normally appear on top or around caches. Troops should therefore be alert to investigate any unusual deformations of the ground along known lines of communications.

DSA, II Corps (G3 Advisor)

CONFIDENTIAL 157 22

SURE PROTECTION



(U) Obtaining Overhead Cover in Night Defensive Positions.

Motivating the individual soldier to dig in after a hard day's march through the jungle requires constant prodding from leaders at all levels of the chain of command. Once the soldier has been motivated to dig, he still must prepare overhead cover for his position. A technique which can be used to expedite the digging and, at the same time, assist in the preparation of overhead cover is to have each man carry a minimum of five sand-bags. The sand-bags can be filled as the dirt is taken from the hole dug for the position. Through the normal process of clearing fields of fire, supports can be obtained for the sand-bags thus providing the necessary overhead cover. The following morning the sand-bags can be emptied and carried to the next night's position. Empty sand-bags do not weigh enough to create an additional burden on the soldier. TF South

CHEMICAL TECHNIQUES

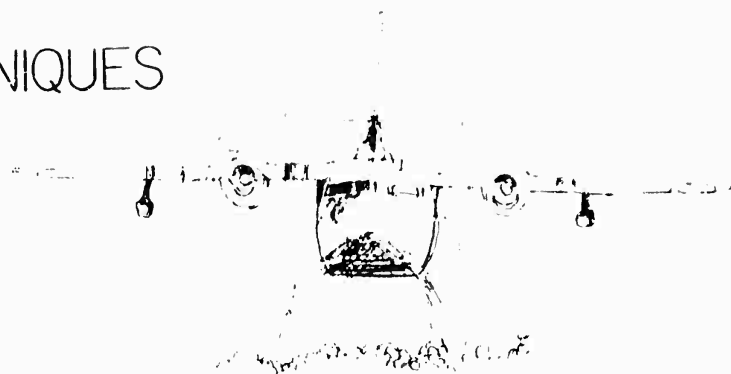

(U) New Technique for Use of the E-8 CS Tactical Launcher for Aerial CS Drops. The E-8 CS Tactical Launcher, although not designed for aerial delivery of CS munitions, has proven useful when aerial dropped from altitudes below 900 feet. Once the E-8 Launcher has been removed from the ground mounting platform, the CS munition can be air dropped with no loss of efficiency due to impact. Area coverage approximately 40 meters wide by 125 to 175 meters deep is obtained and there is a minimum amount of aerial dispersion. Three feet of the lanyard is unwound, the safety pin pulled and the munition pushed from the aircraft. The 3-5 second delay is sufficient to allow the E-8 Launcher to nearly reach the ground prior to release of the CS cannisters. The main advantage of using the E-8 Launcher is the ease of handling and the compactness of the launcher itself.

TF South

(U) Small Area CS Contamination. Small areas or routes may be contaminated easily with riot control agent, CS, by placing several eight-pound bags of CS on a single strand of detonating cord. This method has proven highly successful for pin-point accuracy in contaminating specific routes or defiles around firebase perimeters. Flash due to detonation, which can be excessive, may be greatly reduced by covering the detonating cord with dirt, leaving only the area of contact with the CS bags uncovered. The bags are ruptured by the rapid burning of the cord and produce effective contamination of the immediate area. 4th Inf Div

SHOOTING FROM ALL SIDES



(U) Rear Firing Ports in Bunkers. When preparing covered bunkers or fighting positions consideration should be given to defending the position from all sides. A favorite VC/NVA tactic is to make a diversionary attack with indirect fire weapons on one side of the perimeter while sapper teams breach the perimeter defense on another side. When the enemy succeeds in entering the defensive position, he often is at liberty to attack bunkers from the rear. Construction of firing ports in the rear of bunkers is a necessity to combat these tactics. On 24 Jan 69, the VC attacked an RF/FF position NE of Phan Thiet. This position, although partially overrun, had properly constructed bunkers which undoubtedly contributed to the results of 11 VC KIA while only 3 RF were wounded. TF South

CONFIDENTIAL

TRACK DOWN THE ENEMY



(C) War Dogs. The Provisional War Dog Detachment of the 4th Infantry Division has developed two techniques of employing war dogs which have been beneficial to units in the field. The first technique calls for the use of a Kit Carson Scout with each tracker team to assist in reading trail signs. The second technique is to provide the tracker team with a scout dog and a handler for early warning. One Coyote Tracker Team working with D Troop, 7-17 Cavalry in the vicinity of Plei Lin discovered a track of approximately six individuals running down a trail. The six personnel were believed to have weapons. The tracker team followed a track 800 meters through open fields until arriving where the vegetation became very dense. At this point the Kit Carson Scout pointed out punji stakes and led the way through the jungle pointing out booby traps along the trail. The visual tracker tracked along side the Kit Carson Scout proved to be a valuable supplement to the team. C Co 1-12 Infantry was conducting a search and clear operation and discovered a trail well used in the past five or six hours.

CONFIDENTIAL 162 27

CONFIDENTIAL

A Combat Tracker Team was called. The team arrived and picked up the track. After moving about 800 meters, the scout dog working with the Combat Tracker Team threw a strong alert to the front. The tracker dog did not alert. One hundred fifty meters forward a 150-200 bunker complex was discovered. In the area of the bunkers the unit found 30 mortar rounds, a large quantity of small arms ammunition, chicom grenades and other assorted equipment. By combining the abilities of the two type of dogs, the unit was able to realize more effective results.

4th Inf Div

CONFIDENTIAL 163 28

CONFIDENTIAL

BATTLEFIELD POLICE PAYS OFF



(C) Enemy Use of Recovered Material for Mines.

(1) Enemy Use of Dud Bombs: On Fire Support Base Lillie, Bombs, Fragmentation, (CBU -2), which failed to explode upon impact, were recovered by the NVA. They were placed in the ground with pressure plate covered by a thin layer of dirt; the results were anti-personnel mines. Enemy recovered CBU-2s employed in this manner are likely to be placed on former friendly positions which may in the future be reoccupied by friendly forces.

(2) A new type of homemade bamboo mine was found on 16 February 1969, by elements of the 3d Brigade. This mine consists of a bamboo cylinder, externally wrapped with battery cells from FRC-25 batteries. The mine body consists of a "C" ration can, packed with explosives, and an electric blasting cap. The "C" ration can is sealed with a "C" ration jelly or peanut butter tin. See sketch at Appendix II.

CONFIDENTIAL 164 29

CONFIDENTIAL

(3) On 23 February 1969, the 2-1 Cavalry found a new type of homemade bamboo AP mine. The mine consisted of 2 bamboo tubes, one placed inside the other. The inside tube acts as a plunger. The mine body is filled with explosives, which is detonated by a blasting cap. Usual employment of the mine is in the cracks of asphalt highways. One was destroyed in place producing a hole 6" X 6".

(4) On 28 February 1969 a new type of homemade AP mine was found by the 2-1 Cavalry. The mine consisted of 2-U.D. colored metal cans, with one placed inside the other as a plunger. The mine body was filled with explosive which is set off by a blasting cap. Dimensions of the mine are 5" X 6".

(5) The above incidents underline once again how well "Mr. Charles" polices up the battlefield and uses our junk against us. The lesson learned once again is to clean up after yourself.

4th Inf Div

CONFIDENTIAL 165 30

HELICOPTER SAFETY



(U) Location of Unit Helipads. The winds of Vietnam are relatively consistent in blowing the same direction for one half of the year and the exact opposite direction the other half of the year. Very little variation ever occurs yet new fire bases continue to appear with the helipads either up-wind or down-wind from the camp. This requires helicopters to overfly the camp at low altitudes on approach or takeoff. This is not a desirable situation for the ground troops, and is extremely hazardous to the aircraft. In most cases the heliport could just as easily have been placed in a position that would not require overflying the camp. When the wind prevails from east or west it is a simple rule to place the heliport on the north or south of the fire base whenever possible.

4th Inf Div

CONFIDENTIAL

FRONT VIEW OF A TYPICAL THREE-MAN BUNKER

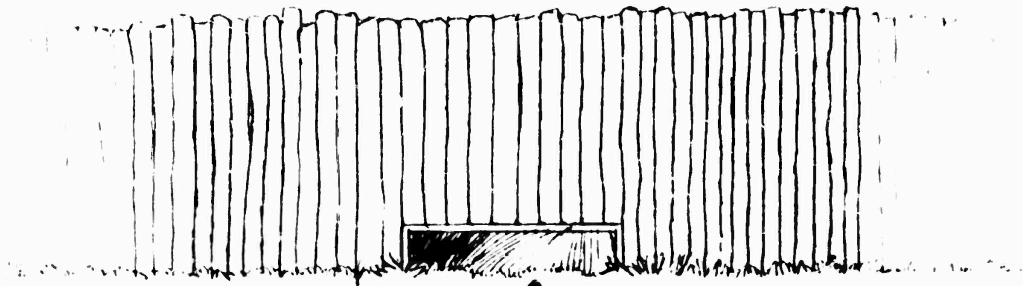

↑ Firing Port (low profile bunker, ideal grazing fire to front)

TOP VIEW OF A TYPICAL THREE-MAN BUNKER

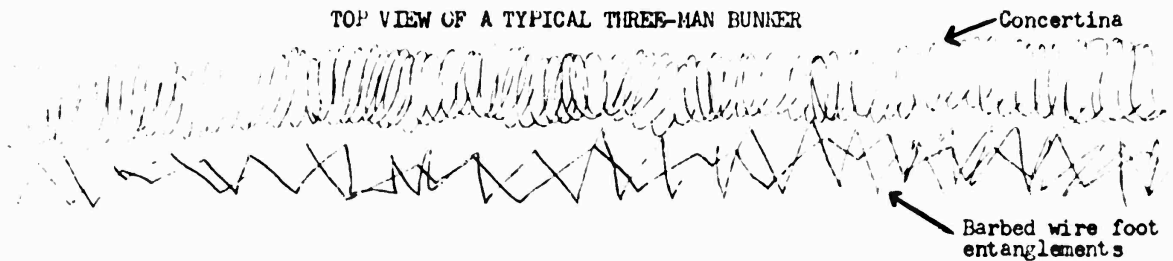

← Concertina

← Barbed wire foot entanglements

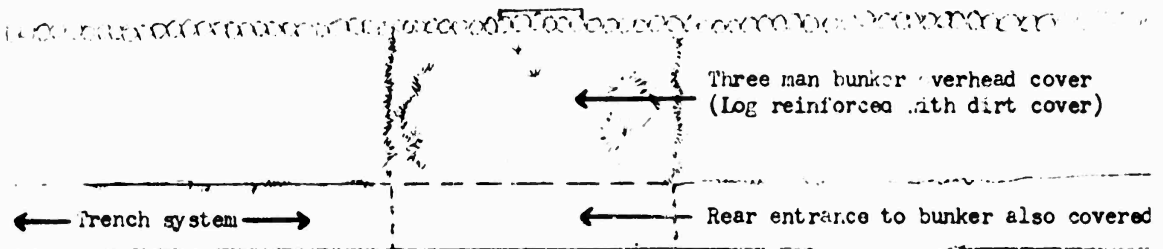

← Three man bunker overhead cover (Log reinforced with dirt cover)

← Trench system →

← Rear entrance to bunker also covered

SIDE VIEW OF TYPICAL THREE-MAN BUNKER

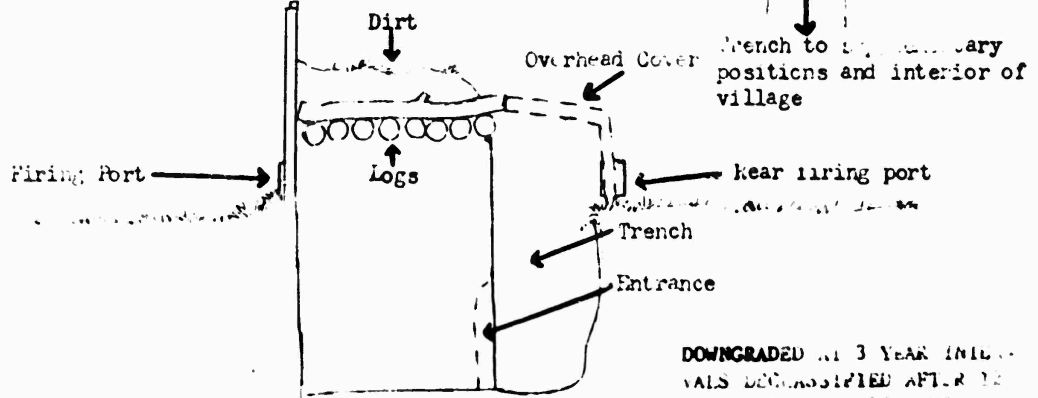

↕ Trench to secondary positions and interior of village

← Firing Port →

← Rear firing port

← Trench

← Entrance

DOWNGRADED AT 3 YEAR INTERVALS
DECLASSIFIED AFTER 25 YEARS, DD FORM 5200 10

CONFIDENTIAL

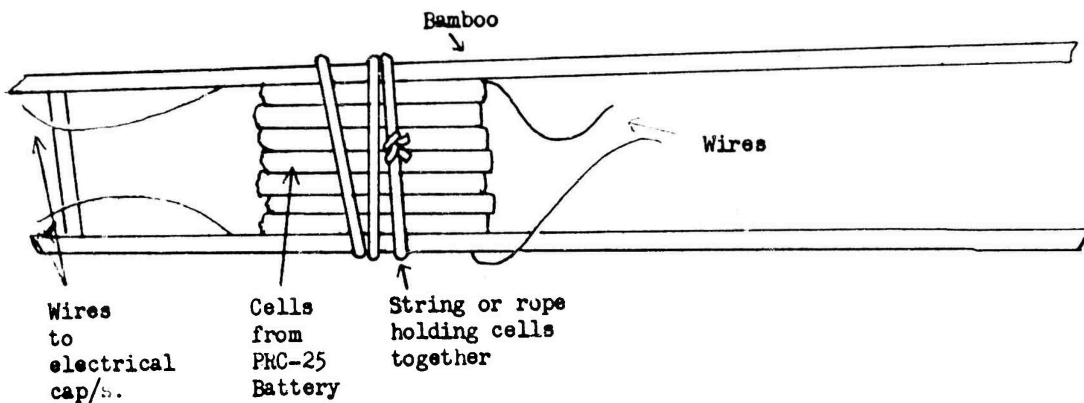

Equipment found by Recon 1/35th Inf on 16 Feb 69

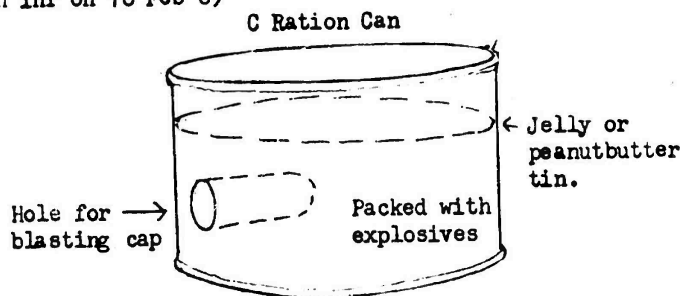

APPENDIX II to Incl 6

ENEMY BAMBOO MINE

DOWNGRADED AT 3 YEAR INTERVALS;
DECLASSIFIED AFTER 12 YEARS.
DOD DIR 5200.10

CONFIDENTIAL

CONFIDENTIAL
**TACTICAL
NOTES**



I FIELD FORCE VIETNAM

IN THIS ISSUE

- * EXPEDIENT BUNKER
- * DEFENSE MEASURES AGAINST SAPPER ATTACKS
- * IMPROVED FIRING
- * USE OF VOLUNTEER INFORMANTS
- * USE OF APC-MOUNTED 81 MM MORTARS



APRIL 1969

**DOWNGRADED AT 3 YEAR INTERVALS;
DECLASSIFIED AFTER 12 YEARS.
DOD DIR 5200.10**

Incl 7

¹⁶⁹
CONFIDENTIAL

CONFIDENTIAL

TACTICAL NOTES

VOL 2 NO 4

I FFORCE V

PURPOSE

In producing TACTICAL NOTES, I FFORCEV Headquarters compiles and highlights in each edition up to date, helpful hints from the counter insurgency battlefields in II Corps Tactical Zone. Study them. Put them to use. Pass them along to others.

Contributions from commanders of all assigned and OPCON units, as well as other organizations receiving the NOTES, including advisors with ARVN units and liaison officers with ROK units, are highly desired and solicited. Pertinent details of "tactical lessons learned" should be recorded as they happen. All contributions submitted should reach this headquarters by the fifteenth of each month.

FOR THE COMMANDER:

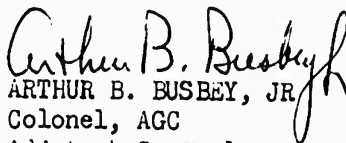
ARTHUR B. BUSBEY, JR.
Colonel, AGC
Adjutant General

DISTRIBUTION:
H

Regraded unclassified when separated
from classified inclosure.

CONFIDENTIAL

170

2

C O N T E N T S

ARTILLERY POINTERS

Indirect Fire Accidents	6
Adjustment of Artillery in Mountainous Terrain	7

PACIFICATION TECHNIQUES

Operation RED DRAGON	8
Countermeasures Against Attacks by Fire	9

PROTECT YOURSELF

Expedient Bunker	10-11
----------------------------	-------

OPERATIONS: USEFUL TACTICAL TIPS

Enemy Use of Allied Slack Periods	12
Ambushing Enemy Basecamps	13
Enemy Caches	14
Enemy Escape Tactics	14
Enemy Exploitation of Established Allied Boundaries	15
Two Ambushes in One Night	15

KNOW YOUR ENEMY

Capture of Enemy Fire Support Weapons 16

PREVENTION OF SAPPER ATTACKS

Enemy Sapper Technique 17

Defensive Measures Against Sapper Attacks. . . . 18-21

MAKE EVERY SHOT COUNT

Improved Firing 22

SECURE COMMUNICATIONS

Joint - Sea Ground Tactical Nestor Keylist. . . 23

MAINTAINING ACCURATE MAPS

Map Updating 24

OBTAINING INFORMATION

Use of Volunteer Informants 25

RAPID PROTECTION

Spider Holes 26-27

NEW MORTAR TECHNIQUES

Use of APC-Mounted 81mm Mortars 28

USEFUL REMINDERS

Halts on Trails	29
Use of Pierced Steel Planking to Recover Mired Track Vehicles	30
Enemy Use of CS Gas	30
Standoff Shield	31
Azimuth Boards	31
Field Expedient Antenna Insulators	32

ARTILLERY POINTERS



(U) Indirect Fire Accidents. Analyses of reports of investigations of recent mortar firing accidents have indicated that double checks are frequently not being performed in the mortar fire direction center or at the mortar tube prior to firing. There is no prescribed system of double checks in field manuals for mortars or artillery; however, the need for such a system has been demonstrated and is successfully being used by artillery units in II Corps Tactical Zone. Successful double check systems require two individuals to compute the firing data independently and to compare the resulting figures prior to transmitting them to the mortars or guns. In addition, double checks should be performed when firing data is placed on the mortars. The initial laying of the mortars and the emplacement of the aiming posts also should be double checked. Consideration should be given to the employment of a double check system within mortar sections in order to improve accuracy and safety. Additional information may be obtained from your direct support artillery.

I FFOhC.V Artillery

174 6

CONFIDENTIAL

(C) Adjustment of Artillery in Mountainous Terrain. When employing artillery in close support of ground troops in mountainous or hilly terrain, extreme care must be exercised by the individual who adjusts the fire. An adjustment towards friendly troops of 200 meters on a steep slope could cause rounds to land among or dangerously close to friendly troops unless map or horizontal distance is used rather than ground distance in determining the required adjustment. See diagram at Appendix I. Squad leaders, platoon leaders and others who may be required to adjust artillery should be cautioned to give corrections in altitude when required and a caution should be included in all classes on artillery adjustment.

DSA, II Corps (G3 Advisor)

CONFIDENTIAL

175 7

CONFIDENTIAL

PACIFICATION TECHNIQUES



(C) Operation RED DRAGON. Recently the 173d Airborne Brigade instituted Operation RED DRAGON to provide an effective reporting system of terrorist activities or attacks against villages and hamlets within the Brigade's areas of operations. Based on the initial report - a RED DRAGON message sent to the Brigade TOC by US personnel at the first headquarters to receive the village/hamlet attack notification - the Brigade dispatches or alerts reaction forces and fire support as requested or required. The RED DRAGON concept establishes an immediate cognizance of high precedence communications traffic throughout the areas of operation of the Brigade thereby minimizing transmission delays caused by congestion and traffic interference. A prearranged message format has been integrated for use with RED DRAGON to provide for expeditious transmission of essential elements of information. The operation has proven very promising in its initial stages and should prove quite successful in achieving rapid response to incidents of this nature, minimizing civilian casualties and damage and forestalling further attacks.

173d Abn Bde

CONFIDENTIAL

176 8

CONFIDENTIAL

(C) Countermeasures Against Attacks by Fire. The current enemy capability of conducting multiple standoff attacks within II CTZ can damage our pacification efforts more than coordinated ground attacks against well defined objectives. It is very hard to tell the rural population that "GVN" can protect them when villages continually receive attacks by fire (ABF). A good way to counter ABFs is by active patrolling. The war in II Corps is apparently reverting back to small unit tactics. With this in mind, consideration should be given to sending platoon size elements into hamlets and villages that may be attacked by the enemy. The platoon could then assimilate RF/PF into its patrols which would be conducted nightly and at intervals with preplanned artillery fires. These patrols seen by residents of villages and hamlets would increase their trust of GVN security promises, plus it gets RF/PF out on patrols. With US support the confidence of RF/PF will surely increase. This technique of decentralizing and active patrolling (not just ambushes) around villages and hamlets should be considered for possible use.

G2 I FFORCEV

CONFIDENTIAL

177 9

PROTECT YOURSELF



(U) Expedient Bunker. The construction of the expedient bunker begins as three prone shelters connected in a Y, with each leg of the Y being a six foot long prone shelter which can be used if attacked during bunker construction. The prone shelters are then deepened until chest high. Support for the overhead cover consists of a bundle of three 4-6 inch diameter logs tied with rope, vines or wire to raise the overhead cover. They should be placed one foot from the edge of the hole to prevent sidewall cave-in. See sketch at Appendix II. Short log bundles, easily cut with a machette, are then placed to cover the entire position, followed by sandbags, waterproofing if available and sufficient spoil for adequate natural camouflage. The base of the Y can serve as a position for the squad or fire team leader. The forward ends of the Y are beveled to approximately 45 degrees for an elbow rest.

See sketch of completed bunker at Appendix III. The use of this expedient bunker has the following advantages:

- a. Allows more than one man to dig at a time.
- b. Utilizes "log bundle" overhead cover support.
- c. Requires no long timbers for overhead cover.
- d. Provides protection from tree bursts, BEEHIVE, and FIRECRACKER rounds.
- e. Presents a low silhouette.

173d Abn Bde

179 11

CONFIDENTIAL

OPERATIONS USEFUL TACTICAL TIPS



(C) Enemy Use of Allied Slack Periods. On 16 March 1969 a Hunter-Killer team ambushing a trail in a fairly open area was surprised when 3 VC walked into its kill zone in a careless manner. Two of the VC were killed and the third was captured. Interrogation revealed that the VC had analyzed allied air and artillery activity and concluded that movement between 1200 and 1400 was relatively safe as few aircraft were flown or artillery missions fired during this period. The prisoner stated that it was his habit to move between these hours. This information complemented intelligence that the enemy moves frequently from 1700-1900 hours for the same reasons. It has long been an Army policy to avoid establishing patterns due to the likelihood of the enemy's taking advantage of them. Since it is apparent that we do set patterns and that the enemy analyzes them and capitalizes on them, it should be possible to analyze our own patterns, determine what advantage the enemy is likely to take of them and use that intelligence against him. As an example, reconnaissance flights are now being made irregularly from 1200-1400 and 1700-1900 hours.

TF South

CONFIDENTIAL

180 12

CONFIDENTIAL

(C) Ambushing Enemy Basecamps. On several occasions companies of the 3d Battalion (Abn), 503d Infantry, have entered enemy basecamps and have either routed the enemy or found the basecamp recently deserted. While searching the area on the day that the basecamps were found or the following days, VC couriers have walked into ambushes established by the security element on trails leading into the basecamp. The VC courier system operates on well established trails and, due to the travel time normally involved in a round trip by the couriers, is likely to continue operation for a short time after the enemy basecamp is entered. The couriers, ignorant of the activities in the area during their trip, will continue to use their normal trails and easily fall prey to well laid ambushes. Quite frequently they are carrying valuable documents or hard to get items critical to the VC operation. Whenever a unit is in the vicinity of a VC basecamp which may have been recently occupied, ambushes on the trails leading into the area should be maintained for several days on the chance of catching couriers returning from a trip. TF South

CONFIDENTIAL

181 13

CONFIDENTIAL

(U) Enemy Caches. Anytime an enemy cache is discovered it is advisable to search the area around the cache thoroughly. It has been found that when VC and NVA have gained confidence in an area they will often place several caches in the same general vicinity. Recently, 3/C/3-506 ABN discovered an enemy weapons and munitions cache. After searching the area around this cache, they found another cache containing twenty-two 82mm mortar rounds. When searching for caches, caution must be exercised, as the enemy is likely to have employed booby traps to discourage personnel from being in the area. TF South

(U) Enemy Escape Tactics. In the 3d Battalion, 503d Infantry AO, the VC usually break contact immediately and attempt to escape. Their procedure once out of sight is to move on trails running diagonal from the flank to the point of contact. This withdrawal procedure is used to avoid artillery fires on escape routes. To counter this enemy tactic, artillery blocking fires and M79 fire have been fired not only to the front but on the left and right flanks immediately after contact has broken with successful results.

173d Abn Bde

CONFIDENTIAL

182 14

CONFIDENTIAL

(C) Enemy Exploitation of Established Allied Boundaries.

Enemy forces remain just beyond fixed AO and province boundaries to avoid contact. Contacts have been made and base areas uncovered when units have swept beyond their normal AO. PW's have revealed that their units remain just beyond a known AO boundary or along the province boundaries, where they believe they are safe from Allied operations. 4th Inf Div

(C) The Ambush in the Night. After an ambush, a US patrol usually withdraws and dumps artillery or mortar fire into the area of contact. The patrol usually returns at first light and sweeps the area to determine the results of the ambush. The enemy is apparently aware of this habit. When ambushed, he usually withdraws, waits for a few hours, and then returns to the kill zone to recover his casualties and equipment. Knowing this, ambush patrols can prepare to engage the enemy again, in the same kill zone but utilizing a different ambush position. This is an effective technique that units should consider when conducting ambushes against squad or platoon size elements. 4th Inf Div

CONFIDENTIAL /S3 15

KNOW YOUR ENEMY



(U) Capture of Enemy Fire Support Weapons. With the continuing emphasis placed by the enemy on utilizing attacks by fire, capture of mortars, PRs and rockets is of paramount importance. In consonance with the "lock on" concept, sector and unit S2s must accurately know the TOE structure and weapon cross attachment techniques of enemy units being targeted. Major collection efforts designed to corroborate and update enemy TOE information, particularly regarding fire support weapons, need to be aggressively pursued. Additionally, rapid field exploitation of PWs will in many cases reveal weapon locations as well as provide updated TOE information. The fact that capture of fire support weapons will drastically effect the accomplishment of the enemy's current mission cannot be overemphasized. Although the enemy has ammunition caches located throughout the zone, his weapons resupply pool is limited. The capture of a mortar is a prize to be sought, since replacement will take weeks. By knowing the enemy TOE an accurate count can be kept and a meaningful estimate of the unit capabilities can be made.

G.I. FORC.V

184 16

CONFIDENTIAL

PREVENTION OF SAPPER ATTACKS



(C) Enemy Sapper Technique. A recent sapper attack of an allied fire base within II CTZ brought out an effective enemy technique. This technique consisted of hoisting satchel charges over the defensive perimeter wire on twenty foot bamboo poles and exploding them, blowing the wire in places and caving in parts of two bunkers. The bunkers where the enemy concentrated their attack were situated above a steep V-shaped ravine. Wire in this location consisted of one row of triple concertina and a row of tanglefoot. Because of the ravine, the wire was located relatively close to the bunkers. We must continually inspect our fire bases and other installations to check for and insure weak spots are reinforced to prevent the enemy from using techniques such as the one discussed here.

G3 I FFOkCv

CONFIDENTIAL

185 17

CONFIDENTIAL

(C) Defensive Measures Against Sapper Attacks. Recently, there have been several successful enemy sapper attacks directed against allied installations within II CTZ. These attacks have proved very costly to us in terms of equipment and supplies destroyed or damaged. The sapper's primary objective is to penetrate friendly defenses, inflict the maximum number of casualties, destroy equipment and bunker complexes within the perimeter, and withdraw. The enemy sapper is a tough, well trained, and highly motivated soldier. He is combat experienced, has received extensive specialized training and is a volunteer. The sapper frequently uses the least likely and most difficult avenues of approach. He takes the time to do so, because use of these avenues offers the best opportunity to work his way between listening posts. Without a doubt the greatest threat to fire support bases and fixed installations in II CTZ is the sapper attack. Sapper attacks follow a standard pattern and can be prevented through the use of imaginative techniques designed to detect the enemy before he begins his assault. The following techniques should be considered for possible use in preventing sapper attacks:

a. Day and Night Recon Patrols. Defending units should prepare and implement as extensive a patrol as possible. The distance the patrol travels and the size of the patrol will be based on enemy activity.

CONFIDENTIAL

186 18

CONFIDENTIAL

b. Deception and Counterintelligence. Plans should be developed to deceive the enemy and hinder his reconnaissance. Such plans should include provisions for false bunkers and gun positions, movement of key installations from time to time, variation in patrol schedules and the emplacement of dummy anti-intrusion devices to augment the actual devices around the perimeter. Effective deception and counterintelligence measures are products of imagination, usually the result of thorough knowledge of sapper techniques combined with ever-changing ideas designed to confuse the enemy.

c. Anti-Intrusion Devices. A unit occupying a fire support base or a fixed installation can never emplace enough anti-intrusion devices. Plans should be made for the continuous improvement of these devices. Mines and booby traps affixed to trip wires must be carefully plotted in the interest of safety. Trip flares should be used in large numbers and when emplaced on high ground overlooking the defensive perimeter or on avenues of approach well away from the perimeter will cause the sapper great difficulty. He expects a pattern of wire, booby traps and trip flares in the general vicinity of the perimeter.

d. Troop Alertness. It is a known fact that the VC/NVA will wait to attack until friendly forces lower their guard. Practice alerts and a system of continuous inspections (particularly during the early morning hours) seem to produce good results.

CONFIDENTIAL

187 19

CONFIDENTIAL

e. Illumination of Defended Area. One of the keys to an effective defense against a sapper attack is illumination. The sapper is trained to operate in the dark, and once he penetrates the perimeter wire, he relies on confusion among the defenders. Periodic illumination (at varied intervals) will assist in the detection of approaching sappers. Illumination once the assault has begun should be carefully planned so that it does not aid the sapper in his attack.

f. Destruction of the Enemy After the Assault has Begun. If the sapper is successful in reaching the perimeter wire without being detected, he is still extremely vulnerable while he is attempting to penetrate the wire. It is here that effective fire from the perimeter guards will pay the greatest dividends. Extensive use of tanglefoot wire between external and internal perimeter wire will keep the sapper in the kill zone for a longer period of time.

g. Bunker Defenses. Bunkers should have properly constructed overhead cover to enable VT fused artillery and firecracker munitions to be called in on the friendly position. Bunkers should be equipped with standard, functional range cards. Consideration should be given to replacing above - ground, high silhouette bunkers with below - ground low silhouette bunkers. When preparing bunkers consideration should be given to insure the occupants are able to fire from all sides of the bunker. Flash walls should be constructed

CONFIDENTIAL

188 20

CONFIDENTIAL

to provide protection for bunker entrances.

h. Reaction force and internal firing. Every defensive position should have a reaction force, whose mission is to assault enemy elements who have penetrated the wire.

i. Use of signals. Some provisions should be made to alert everyone within the perimeter, as well as listening posts outside the perimeter, when a penetration has been made. A visual signal, such as a red flare, is perhaps the most effective signal due to noise and confusion that exist during the initial phases of the assault.

In any sapper attack, the sapper unit is outnumbered by the defending force. He must have time, he must achieve surprise and is only effective if he can operate in the darkness. The techniques discussed here, if properly utilized, can cause "Charlies's" sapper attacks to fail.

G3 I FFORCEV

CONFIDENTIAL

MAKE EVERY SHOT COUNT



(C) Improved Firing. A general inability to engage the enemy with effective, aimed fire by 4th Infantry Division soldiers indicated the need for improving the marksmanship of the individual soldier. Replacements appeared reasonably proficient in quick fire techniques, but demonstrated extremely limited skill in engaging point targets. An analysis of their problems, using the standard Preliminary Rifle Instruction (PRI) techniques, has revealed that the major problem is their failure to understand and employ correct sight picture and sight alignment. Consequently, the 4th Infantry Division is requiring each replacement with a combat military occupational speciality to undergo four hours of PRI and eight hours of range firing on a 200 meter Known Distance (KD) range. The replacements demonstrate a marked improvement in their ability to engage point targets after completing the 12-hour block of instruction. This procedure should be considered for possible use to increase the effectiveness of small arms firing.

4th Inf Div

CONFIDENTIAL

190 22

CONFIDENTIAL

SECURE COMMUNICATIONS



(C) Joint - Sea Ground Tactical Nestor Keylist. On or about 1 June 1969, a Joint - Sea Ground Tactical Nestor Keylist II Corps (AKAK 8160) for use by all U.S. ground tactical units within II CTZ will be implemented. This new Corps-wide keylist has been designated AKAK rather than USKAK in order that it may be released to Australian forces. The purpose of the corps keylist is to improve the computability of secure voice communications between adjacent units while at the same time simplifying and improving command and control where elements of one unit are placed under operational control of another unit. Navy units operating within II CTZ will also have AKAK-3160 to be used when conducting support missions. The AKAK-3160 is not meant to restrict, deny, or curtail the use of small specialized keylists; however, it can be expected that this keylist will permit some consolidation or phase-out of other keylists now being used. Signal I FFORCEV

CONFIDENTIAL

191 23

CONFIDENTIAL

MAINTAINING ACCURATE MAPS

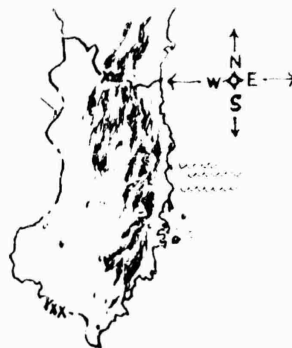

(C) Map Updating. The accuracy of non-permanent features such as villages and hamlets on tactical maps used in South Vietnam is questionable. Many hamlets and villages have been destroyed or relocated since the last engineer survey was conducted in 1966. A system initiated by Darlac Province Advisory Team has proven very useful in updating tactical maps. During routine flights each day, the sector visual reconnaissance pilots and Air Force forward air controllers confirm the exact location of several existing villages and hamlets and note those which have been abandoned or destroyed. This information is posted on the sector operations map and over an extended period of time sector has thus obtained an accurate map portrayal of man-made features. This technique should be considered for possible use in updating maps.

DSA, II Corps (23d DTA)

CONFIDENTIAL

192 24

CONFIDENTIAL



OBTAINING INFORMATION

(C) Use of Volunteer Informants. One of the primary sources of current information about enemy activity is the volunteer informant. There are several important factors to remember when collecting information from volunteer informants. Some of these are:

(1) The information obtained from volunteer informants is normally highly perishable. Commanders and their S-2s must learn to quickly judge the informant and information, then decide whether or not to react immediately on the information.

(2) It must be kept in mind that the individual is volunteering information (this in itself lends credibility to the information). The fact that an individual refuses to accompany friendly units on an operation does not mean that the information is false. In many areas being seen with allied troops could result in serious reprisals to the informant.

(3) Publicity is the key factor in the Volunteer Informant Program. The population must know when and where to report information, as well as what rewards they can expect. To insure acceptance of the program, payments must be made as announced and promptly.

DSA, II Corps (G2 Advisor)

CONFIDENTIAL

193 25

CONFIDENTIAL

RAPID PROTECTION



(C) Spider Holes. A useful and quick way to establish a hasty night defensive position is by using an old VC technique - the spider hole. The VC use the spider hole as a means of concealment and as a fighting position. Units which have been ambushed can attest to its worthiness. A spider hole offers the occupant excellent concealment and protection from grenades and direct and indirect weapons fire. When the friendly unit closes into its night defensive area two man positions are picked and made immediately. While one man is providing security the second man digs the one man spider hole. It is dug only shoulder wide but larger at the bottom to allow the occupant to bend his knees. To insure that the spider hole affords maximum concealment the dirt must be removed from the vicinity of the spider hole and the position must be covered and camouflaged without the standard revetments found around the normal two or one man foxholes. As soon as the spider hole position is dug and occupied the second man digs a prone sleeping shelter immediately behind the spider hole. This shelter is dug so that the man is just below the surface of the ground when sleeping. It is dug in the same

CONFIDENTIAL 194 26

CONFIDENTIAL

manner as the spider hole, affording the same cover and concealment. If time permits a second spider hole is dug which would be used as the second man's fighting position. However, if time doesn't permit, the prone shelter is then used as a hasty fighting position. Both shelters can be dug in approximately half the time it takes to construct the standard two-man foxhole and affords maximum cover and concealment while still providing the standard perimeter defense of a two man position with one man sleeping and the other awake.

DSA, II Corps (G3 Advisor)

CONFIDENTIAL

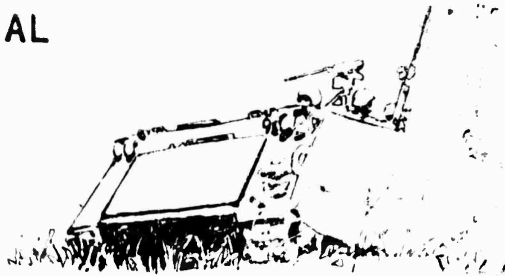

NEW MORTAR TECHNIQUES

(C) Use of APC-Mounted 81mm Mortars. While engaged in highway security missions north of Pleiku, the 3d Armored Cavalry Squadron developed a mortar displacement technique to solve the problem of security during displacement of the squadron's 81mm mortar section. During road opening operations, the 3d Cavalry found that the standard practice of displacing the mortar section by echelon created security risks because of the possibility of ambush along the highway and failed to provide continuous coverage when the leading troop outran the displacing mortars. The concept presently in effect is to keep the mortar section with the main force. As the mortar carriers move with the operation they place sheaths of fire with fixed charge, elevation and deflection while the carrier is moving from 5 to 10 miles per hour. The gunners have become so efficient in this method of firing that the bursts land right at the woodline spaced every 50-100 meters. Employing the mortars in this method allows for continuous fire support, eliminates the requirement for additional security, and supplements the unit's reconnaissance by fire with a much more devastating fire. DSA, II Corps (3d ACAV Sqdn)

CONFIDENTIAL

196 28

CONFIDENTIAL

USEFUL REMINDERS



(C) Halts on Trails. Recently a platoon sized element stopped to rest along a trail. The forward security elements sighted a VC approaching on the trail, but the VC also sighted the friendly element at the same time. The VC was engaged with small arms fire but escaped. The encounter serves as a reminder that when a halt is called along a trail, the main body should set up security off the trail while the forward and rear security elements establish themselves in ambush positions beside the trail.

173d Abn Bde

CONFIDENTIAL

197 29

CONFIDENTIAL

(C) Use of Pierced Steel Planking to Recover Mired Track Vehicles. Armored Personnel Carriers (APCs) employed in rice paddies often become mired in an area where the distance to firm ground exceeds the length of available recovery cable. APCs, in some cases tanks, have been successfully recovered by placing a strip of "PSP" in front of each track and driving the vehicle onto them. This expedient is the most efficient when at least four strips of PSP are available, two supporting the tracks and the other two placed in front of the vehicle to move it forward. The PSP is carried externally on each side of the vehicle and so can be rapidly emplaced and can provide some benefit by the stand-off created as a defense against shaped charge munitions. DSA, II Corps (22d BTA)

(C) Enemy Use of CS Gas. During a recent sweep operation following an enemy mortar attack on its night location, a Regional Force company captured 22 rounds of 82mm mortar ammunition. All of these rounds contained CS or a similar riot control agent. All troops should be apprised of this and as a minimum all compound security guards should be required to carry a protective mask. A few well placed riot control munitions in or near defensive positions could offer an excellent means for sappers to cover their penetration of perimeters if the perimeter security personnel are not carrying protective masks. DSA, II Corps (22d BTA)

CONFIDENTIAL 198 30

CONFIDENTIAL

(C) Standoff Shield. When assaulting fortified positions, armored vehicles usually sustain hits on the front slope from rockets or hanging mines. Some ARVN armored cavalry units have adopted a policy of extending the trim vane on the front of armored personnel carriers. Experience has proven that this expedient provides a degree of standoff protection against anti-tank munitions which utilize the shaped charge principle for penetration.

OSA, II Corps (22d DTA)

(C) Azimuth Boards. With the increase of mortar and rocket standoff attacks, speed and accuracy in locating enemy firing positions during these attacks is of paramount importance. The presence of an azimuth board in perimeter guard towers has proven helpful in locating enemy firing positions during standoff attacks. The azimuth board is simply a piece of wood, preferably round, with the direction readings in mills marked on it. The board is oriented North and has a movable arrow mounted on it. Once the guard spots a flash from a firing position, he orients the arrow in the direction of the flash and reads the azimuth. The azimuth reading is then passed to the FSCC for use in employing counter battery fires.

OSA, II Corps (23d DTA)

CONFIDENTIAL

199

31

CONFIDENTIAL

(C) Field Expedient Antenna Insulators. Many tactical antenna installations, particularly HF/SSB are installed in such a manner that very poor efficiency is obtained. A prime cause of this poor efficiency is poorly insulated antenna wires. Without a properly insulated antenna radiating wire, field antennas are subject to being shorted to ground which always results in an antenna of limited usefulness and may render antennas totally useless. Many types of commonly found items can be used as field expedient insulators. Best among these are items of plastic or glass, i.e., C-ration spoons, buttons, bottle necks, or plastic bags. Less effective than plastic or glass but still better than no insulator at all is a piece of wood, rope, or cloth in that order. The radiating element is the actual antenna wire. This wire should not touch anything but the radio antenna terminal and should be physically separated from all other objects, i.e., poles, buildings, trees and other wires of any type. This separation can be accomplished in an expedient manner by use of the insulators previously mentioned. Tie a piece of string to the foreign object, tie the expedient insulator to this string, tie a second piece of string to the insulator and tie the other end of the second string to the antenna wire.

DSA, II Corps (Signal Advisor)

CONFIDENTIAL

200 32

APPENDIX I

ADJUSTMENT OF ARTILLERY IN MOUNTAINOUS TERRAIN

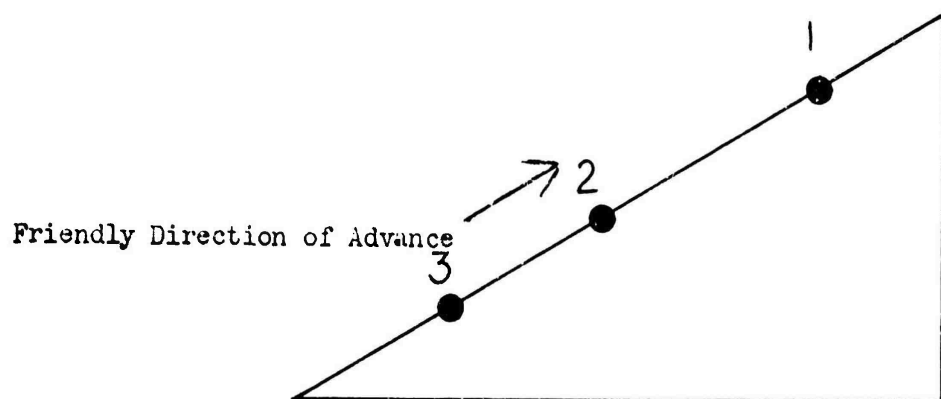

1. Impact First Round
2. Desired Impact Second Round
3. Actual Impact Point Second Round

APPENDIX I to Incl 7

APPENDIX II

EXPEDIENT BUNKER WITHOUT OVERHEAD COVER

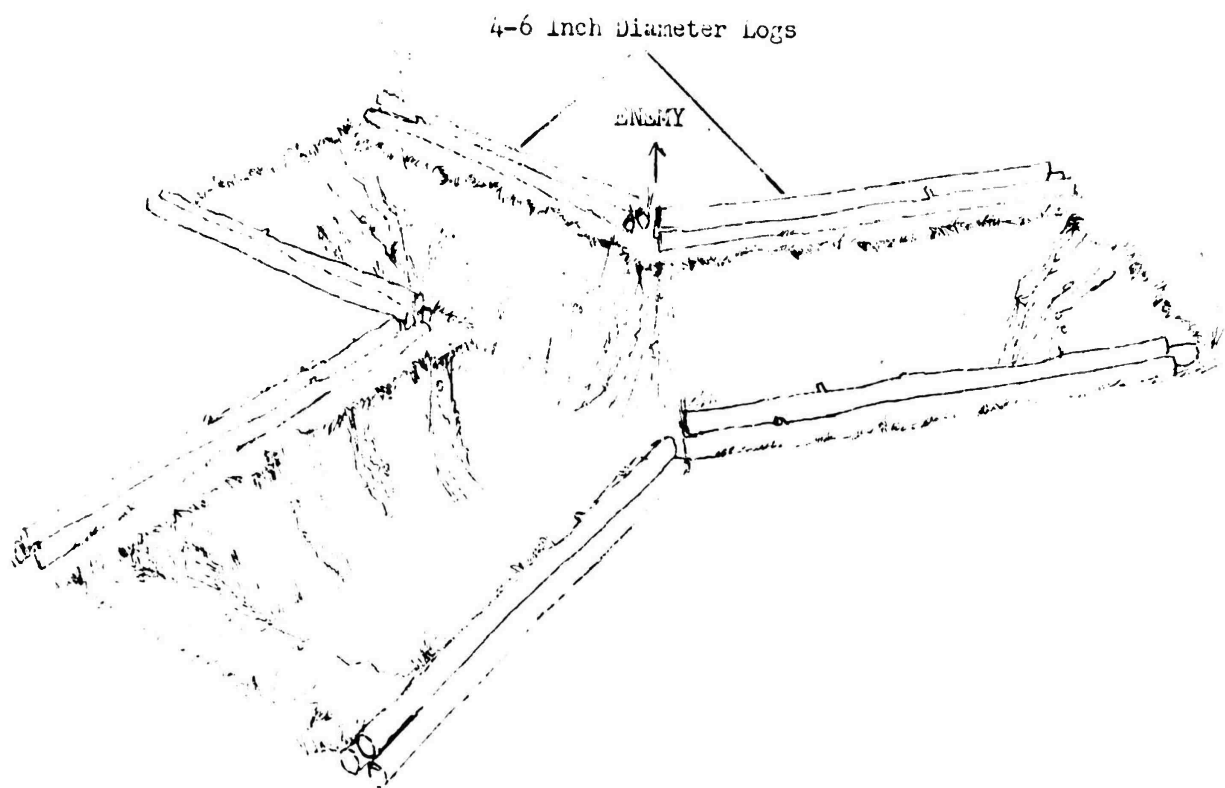

APPENDIX II to Incl 7

APPENDIX III

COMPLETED EXPEDIENT BUNKER

